

TURBOPOWER® 96 CONDENSING GAS WATER HEATERS

AquaPLEX® Storage Tank (duplex stainless steel)

Model No. 75 L 600A-TPX	
Btu Input	750,000
Recovery GPH 70°F to 140°F ①	1239 (96% E _T)
Recovery GPH 40°F to 140°F	881 (97.5% E _T)
Storage Capacity - gallons	575
Gas Pressure Maximum Static	14" W.C.
Gas Pressure Minimum Flow	3.5" W.C.
Amperage (120VAC, 60Hz.)	11
Max. Inlet Air Duct Length @ 6" dia.	100 ft. with four 90° ells
Max. Vent Length @ 6" dia. ②	100 ft. with four 90° ells
Shipping Weight lbs.	2510

- ① Per DOE, 10 CFR 431 (ANSI Z21.10.3 @ 70°F to 140°F)
- ② Listed for category IV venting through PVC, CPVC, polypropylene, or single-wall stainless steel vent. Refer to manual for design requirements. Longer vents available with larger diameter.
- Dimensions are in inches unless otherwise noted. For standard and optional equipment, refer to form PV 8820. Water heater must **NOT** be oriented horizontally.

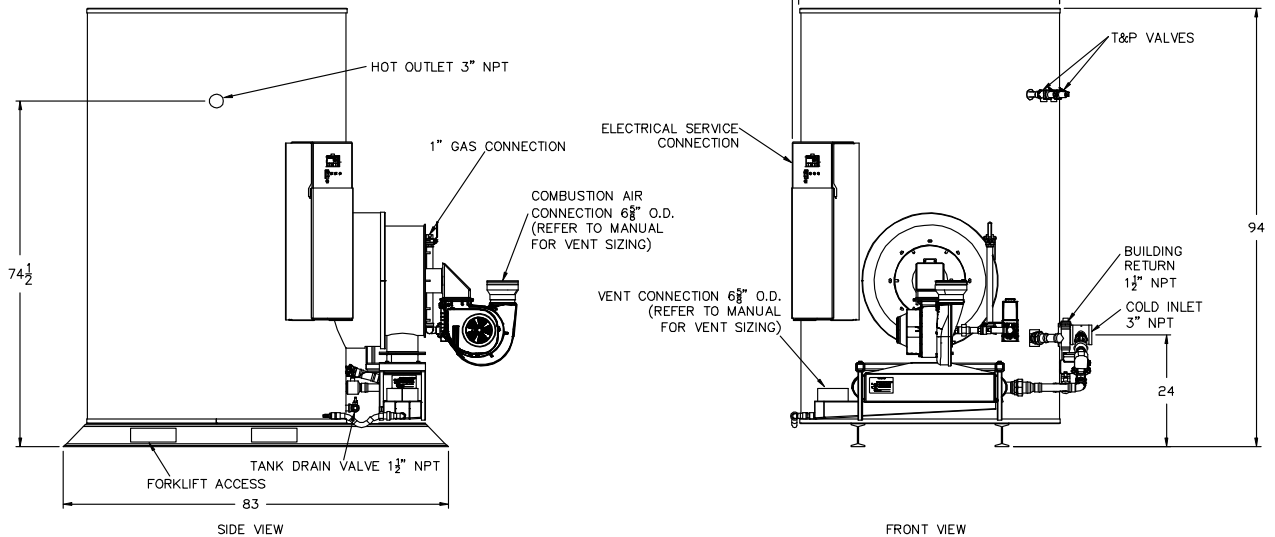
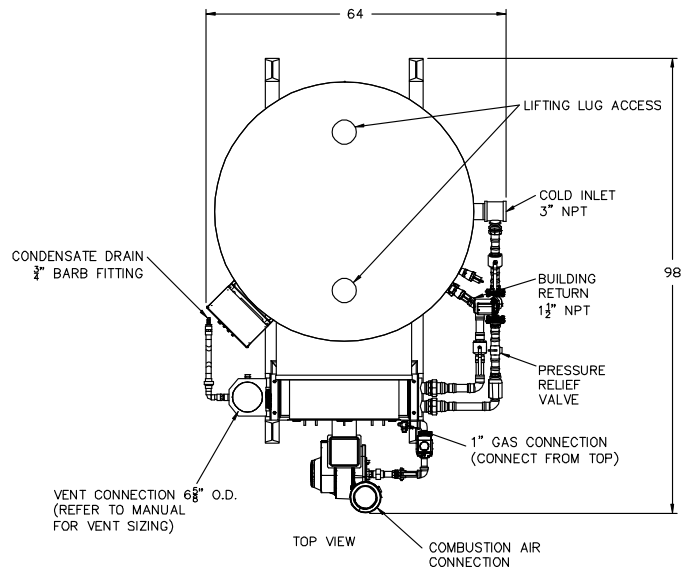

Recommended Service Clearance: 18" from all sides, 12" from the top. Consult factory for heat exchanger pull space requirements.
 Minimum Clearances: 6" from all sides and top, 24" from the front.

