

User Guide & Instruction Manual

DigiTemp[®] Jr.

Digital Water Mixing Valve



Important: Read this Manual BEFORE using this equipment. Failure to read and follow all safety and use information can result in death, serious personal injury, property damage, or damage to the equipment.

Keep this Manual for future reference.

Manufacturing ASME Commercial Water Heaters Since 1961

PV8741 3-2022

PVI Industries, LLC • Fort Worth, TX 76134

USA: T: (817) 335-9531 • Toll Free: (800) 784-8326 • PVI.com

Technical Support • (800) 433-5654 (ext. 3) • customer-care@pvi.com • Mon-Fri, 8 am - 5 pm EST

© 2022 PVI



Heating & Hot Water Solutions

LIMITED WARRANTY / LIMITATION OF REMEDY:

What is covered? Watts Heating & Hot Water Solutions warrants to the original purchaser only, that the product it manufactured when used as intended and instructed, is free from defects in materials or workmanship for five year warranty from date of shipment to the original purchaser.

What is not covered? This Limited Warranty does not cover or is voided by (a) any product, components or parts not manufactured by Watts Heating & Hot Water Solutions, (b) faulty or improper installation or unsuitable installation environment, (c) failure to follow instructions or warnings, (d) problems caused by unauthorized attachments, modification, repairs or parts, (e) negligence or vandalism, (f) problems due to foreign material, adverse or improper water conditions, chemicals, contamination, improper pH, water treatment activities or products, mineral deposits, or decomposition by galvanic action, (g) shipping defects or damage, (h) normal wear and tear, (i) any abuse, misuse, unintended use, failure to maintain or inspect, (j) any circumstances over which Watts Heating & Hot Water Solutions has no control.

IN NO EVENT SHALL WATTS HEATING & HOT WATER SOLUTIONS BE LIABLE TO BUYER OR THIRD PARTIES FOR ANY GENERAL, SPECIAL, INCIDENTAL, OR CONSEQUENTIAL DAMAGES INCLUDING, BUT NOT LIMITED TO, PROPERTY DAMAGE, PERSONAL INJURIES, LOST PROFITS, LOSS OF SAVINGS OR REVENUE, LOSS OF THE USE OF THE PRODUCT OR ANY ASSOCIATED PRODUCTS, COST OF REPAIR, COST OF ANY SUBSTITUTE PRODUCTS OR SERVICES, DELAY DAMAGES, LABOR CHARGES, FINES/ PENALTIES, ECONOMIC OR NON-ECONOMIC LOSSES, ARISING DIRECTLY OR INDIRECTLY FROM THE SALE/PURCHASE, OWNERSHIP, INSTALLATION, OR USE OF THE PRODUCT, WHETHER BASED ON BREACH OF WARRANTY, BREACH OF CONTRACT, NEGLIGENCE, STRICT LIABILITY, OR ANY OTHER LEGAL THEORY.

What will Watts Heating & Hot Water Solutions do? THE SOLE AND EXCLUSIVE REMEDY UNDER THIS LIMITED WARRANTY OR ANY IMPLIED WARRANTIES, is:

Within a reasonable period of time after receiving a timely and bona fide claim, Watts Heating & Hot Water Solutions will at its sole option (a) repair the product, or (b) replace the product (or component) with a same or similar product. A replaced product is warranted for 90 days from the date of return shipment, or for the balance of the original Limited Warranty period, whichever is longer. **IN NO EVENT SHALL WATTS HEATING & HOT WATER SOLUTIONS LIABILITY EXCEED AN AMOUNT EQUAL TO THE SALES PRICE OF THE PRODUCT.**

To obtain warranty service: Contact Watts Heating & Hot Water Solutions at (800) 433-5654 (opt. 3) with description of the problem and proof of the date of original purchase. Cost of shipping and insuring returned product must be paid by purchaser. Watts Heating & Hot Water Solutions is not responsible for any loss of damage to the product incurred during shipping.

Disclaimer of other warranties: THIS LIMITED WARRANTY IS IN LIEU OF ALL OTHER WARRANTIES, EXPRESS OR IMPLIED. ALL IMPLIED WARRANTIES, INCLUDING THE IMPLIED WARRANTIES OF MERCHANTABILITY AND FITNESS FOR A PARTICULAR PURPOSE, ARE DISCLAIMED.



Heating & Hot Water Solutions

COMPUTER SYSTEM, NETWORK AND DATA DISCLAIMER:

DigiTemp® Jr. receives stores and displays data concerning your water distribution system, performs functions based upon owner/user data input and selections, and can be remotely programmed and utilized with specified and compatible building automation systems.

AS SUCH, WATTS HEATING & HOT WATER SOLUTIONS MAKES NO EXPRESS OF IMPLIED WARRANTY, INCLUDING WARRANTIES OF MERCHANTABILITY AND FITNESS FOR A PARTICULAR PURPOSE, REGARDING COMPATIBILITY WITH OTHER TECHNOLOGIES, HARDWARE, SOFTWARE, NETWORK OR SYSTEMS, THE ACCURACY OR COMPLETENESS OF ANY DATA, THE SECURITY OF ANY COMPUTER NETWORK OR SYSTEM, OR ANY RESULTS TO BE ACHIEVED FROM THE DIGITEMP® JR.s OR ANY COMPUTER NETWORK OR SYSTEM. WATTS HEATING & HOT WATER SOLUTIONS HAS NO RESPONSIBILITY OR LIABILITY ARISING FROM: THE UNAUTHORIZED USE OF THE DIGITEMP® JR; THE CONNECTION TO OR INTEGRATION WITH A USER'S OR ANY OTHER COMPUTER NETWORK OR SYSTEM; ANY HARDWARE OR SOFTWARE NOT SUPPLIED BY WATTS HEATING & HOT WATER SOLUTIONS; ANY DATA THAT IS INCORRECT, CORRUPT OR CORRUPTED, LOST, STOLEN OR PIRATED; ANY FAILURE TO SECURE THE DIGITEMP OR THE USER'S OR ANY OTHER COMPUTER NETWORK OR SYSTEM; ANY "CRASHING" OR TEMPORARY/ PERMANENT INOPERABILITY OF DIGITEMP OR ANY COMPUTER NETWORK OR SYSTEM; ANY UNAUTHORIZED USES, USERS, OR INTRUDERS OF THE DIGITEMP OR ANY COMPUTER NETWORK OR SYSTEM; ANY INTENTIONAL OR UNINTENTIONAL VIRUSES OR CORRUPTION OF ANY KIND OF THE DIGITEMP OR ANY COMPUTER NETWORK OR SYSTEM; OR ANY THIRD PARTY ACTION SUCH AS HACKING OR UNAUTHORIZED ACCESS OR USE OF THE DIGITEMP® JR OR ANY COMPUTER NETWORK OR SYSTEM.

Table of Contents

Introduction	2
Safety Information	3
Understanding Safety Information	3
Radio Frequency Warnings & Hazards	3
DigiTemp® Jr. Description & Specifications	4
DigiTemp® Jr.	7
Set up and Programming	9
BAS Integration Manual	16
Sanitization	27
Time Function	31
Monitor Function	37
Toolbox Function	39
Troubleshooting	43
Scheduled Testing, Inspection and Maintenance	47

Attention Owners and Users

Thank you for purchasing the **Watts Heating & Hot Water Solutions DigiTemp® Jr.** This equipment will provide safe and productive operation as long as it is installed, set up, used, and serviced in accordance with the instructions in this manual and is properly maintained. Owners and users of this equipment have the responsibility to make certain that this equipment is used properly and safely. To avoid the possibility of death, serious personal injury, property damage, or damage to the equipment, owners should not permit anyone to touch this equipment unless they are over 18 years of age, are adequately trained and supervised, and have read and understand this manual. Owners should ensure that no unauthorized personnel come in contact with this equipment.



READ THIS MANUAL carefully, learn how to install, set up, use, service and maintain this equipment correctly, and strictly follow all safety information and instructions

contained in this manual and on the equipment, as well as any requirements of local, state, and federal law. Failure to do so could result in death, serious personal injury, property damage, or damage to the equipment. This manual should be considered a permanent part of the DigiTemp® Jr. and be kept available for easy reference by any user.

If this equipment, or any of its parts, becomes damaged or needs repair, stop using the

equipment and contact an experienced service individual immediately. If the product labels or this Manual are misplaced, damaged or illegible, or if you require additional copies, please visit watts.com.

Please remember that this manual and the product labels do not replace the need to be alert, to properly train and supervise users, and to use common sense when using this equipment.

If you are ever uncertain about a particular task or the proper method of operating this equipment, ask your supervisor, consult this manual, visit our website, or contact your local sales representative.

Product Identification

Please record your product's identification and purchase information which will help in the event you have questions or need any service.

Model:	Date of purchase: Seller name / address:
---------------	---

Important Safety Information

Reading & Understanding the Manual

WARNING



TO AVOID DEATH, SERIOUS PERSONAL INJURY, PROPERTY DAMAGE, OR DAMAGE TO THE EQUIPMENT:

- Read the manual and all product labels and follow all safety and other information.

- Learn how to properly and safely use the equipment **BEFORE** installing, set up, using, or servicing.
- Keep the manual available for easy access and future reference.
- Replace missing, damaged, or illegible manual and product labels.
- Replacement manuals available at watts.com

Understanding Safety Information



This safety-alert symbol is shown alone or used with a signal word (DANGER, WARNING, or CAUTION), a pictorial and/or a safety message to identify hazards and alert you to the potential for death or serious personal injury.



This pictorial alerts you to the need to read the manual.

DANGER

Identifies hazards which, if not avoided, will result in death or serious injury.



This pictorial alerts you to scalding, burn and hot water hazards.

WARNING

Identifies hazards which, if not avoided, could result in death or serious injury.



This pictorial alerts you to burn and hot surfaces hazards.

CAUTION

Identifies hazards which, if not avoided, could result in minor or moderate injury.



This pictorial alerts you to electricity, electrocution, and shock hazards.

NOTICE

Identifies practices, actions, or failure to act which could result in property damage or damage to the equipment.



This pictorial alerts you to the need to perform appropriate Lock Out/ Tag Out procedures.

DigiTemp® Jr. Description and Specifications

DigiTemp® Jr. are electronic water mixing valves providing user-directed control and monitoring water distribution. They include an electronic Control Module featuring a color touch screen digital display to select desired outlet water temperature, an electronically actuated valve that mixes hot and cold water, a quick response temperature sensor and check valves. These electronic mixing valves monitor mixed outlet temperature. They also feature a user programmable high temperature Sanitization mode to help limit water borne bacteria as part of a user-directed and controlled thermal eradication protocol.

These electronic mixing valves supports building automation system (BAS) communication with BACnet MSTP and Modbus protocol, allowing remote programing and data viewing.

Installation and adjustment of these electronic mixing valves are the responsibility of the owner and installer and must be done by qualified personnel in accordance with the manufacturer's instructions, and complying with all governmental requirements, building and construction codes and standards. It is recommended to install DigiTemp® Jr. as part of a water distribution system compliant with local codes, including mixing valves and/or temperature limiting devices at all point-of-use fixtures (faucets, sinks, tubs, showers, etc.) that are approved to ASSE 1016, 1069, 1070 and 1071. The owner and user of the DigiTemp Jr. is responsible for selecting and installing the product in an appropriate water distribution system, proper sizing, maintaining proper water quality/condition, and deciding what temperature is safe and appropriate for the water distribution users and facility.

DigiTemp® Jr. Description and Specifications

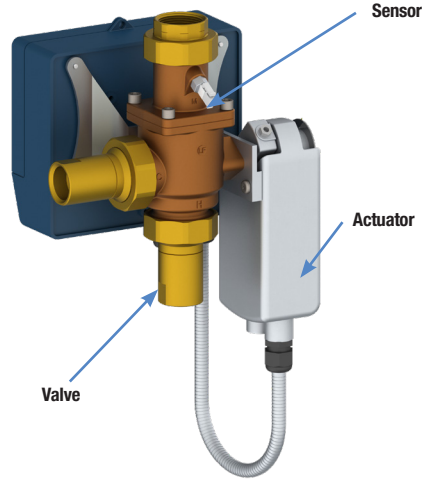
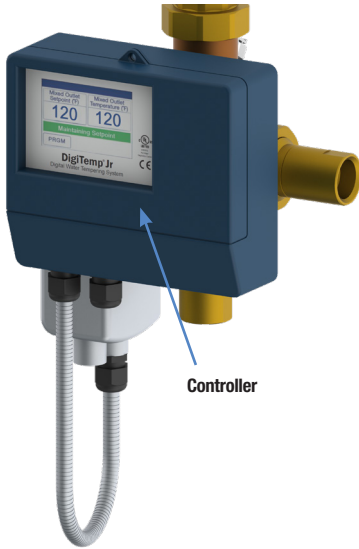

Dimensions

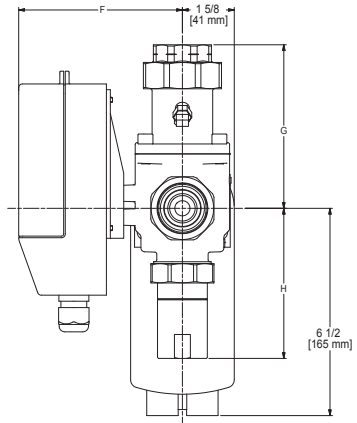
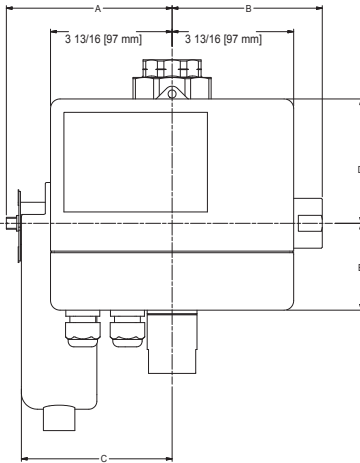

Model	Inlets	Outlet	A	B	C	D	E	F	G	H
V23	3/4" (20 mm)	3/4" (20 mm)	47/8" (123 mm)	4 1/16" (103 mm)	4 3/8" (110 mm)	4 1/16" (103 mm)	2 9/16" (66 mm)	4 3/4" (120 mm)	4 5/16" (110 mm)	4 1/8" (105 mm)
V55	1" (25 mm)	1 1/4" (32 mm)	5 3/16" (132 mm)	4 1 1/16" (120 mm)	4 3/4" (120 mm)	3 7/8" (99 mm)	2 3/4" (69 mm)	5 5/8" (130 mm)	5 5/8" (130 mm)	4 1 1/16" (120 mm)
V71	1 1/2" (38 mm)	1 1/2" (38 mm)	5" (135 mm)	6 1/4" (159 mm)	5 1/16" (129 mm)	2 1/8" (54 mm)	4 1/2" (114 mm)	4 7/8" (124 mm)	5 5/8" (135 mm)	5 5/8" (147 mm)
V125	2" (51 mm)	2" (51 mm)	5 2/3" (144 mm)	6 2/3" (169 mm)	5 2/5" (137 mm)	2 1/8" (54 mm)	4 1/2" (114 mm)	4 7/8" (124 mm)	5 2/3" (144 mm)	6 1/5" (158 mm)

DigiTemp® Jr. Description and Specifications

Specifications

Maximum Operating Pressure	200psi (1379 kPa)
Maximum Hot Water Temperature	200 °F (93 °C)
Minimum Hot Water Supply Temperature**	2 °F (1 °C) Above Set Point
Hot Water Inlet Temperature Range	120 – 180 °F (49-82 °C)
Cold Water Inlet Range	39 – 60 °F (4-16 °C)
Minimum Flow***	0.5 gpm (1.89 lpm)
Temperature Adjustment Range****	60 – 180 °F (16-82 °C)
Listing/Compliance	ASSE1017®, cUPC®, NSF®, UL60730, CE
Weight.....	V23 13lb (6kg)
.....	V55 17lb (8kg)
.....	V71 23lb (10kg)
.....	V125 26lb (12kg)

**With Equal Pressure

***Minimum flow when DigiTemp® Jr. is installed at or near hot water source recirculating tempered water with a properly sized continuously operating recirculating pump (5 gpm minimum).

****Low limit cannot be less than the cold water temperature. For best operation, hot water should be at least 2°F above desired set point.

Technical Specifications

Power.....	115-230 V (ac) ± 10%, 50/60 Hz, 20 VA
Actuator load:.....	24 V (dc), 0.55 A, 13 W

Capacity

Flow Capacity at 50-50 Mixed Ratio							
Model	cv	Pressure Drop Across Valve					
		5 psi 34 kpa	10 psi 69 kpa	20 psi 138 kpa	30 psi 207 kpa	45 psi 310 kpa	50 psi 345 kpa
V23	7.3	16 gpm 61 lpm	23 gpm 87 lpm	33 gpm 125 lpm	40 gpm 151 lpm	49 gpm 185 lpm	52 gpm 197 lpm
V55	17.5	39 gpm 148 lpm	55 gpm 208 lpm	78 gpm 295 lpm	96 gpm 363 lpm	117 gpm 443 lpm	124 gpm 469 lpm
V71	22.5	50 gpm 189 lpm	71 gpm 269 lpm	101 gpm 382 lpm	123 gpm 466 lpm	151 gpm 572 lpm	159 gpm 602 lpm
V125	39.5	88 gpm 333 lpm	125 gpm 473 lpm	177 gpm 670 lpm	216 gpm 818 lpm	265 gpm 1003 lpm	279 gpm 1056 lpm

Installation

⚠ WARNING



Failure to follow all installation requirements risks possible death, personal injury, property damage, and failure of the DigiTemp® Jr. to perform as intended.

- Installation of these valves **MUST** be performed by qualified technicians, including licensed electricians and plumbers, following all manufacturer's instructions, complying with all local, state, federal and other governmental requirements, and with all building and construction codes and standards.
- Use **ONLY** with a potable water distribution system free of debris, foreign materials, corrosive chemicals or substances, and other adverse conditions.
- DigiTemp® Jr. is recommended for use as part of a water distribution system compliant with local codes, including mixing valves and/or temperature limiting devices at all point-of-use fixtures (faucets, sinks, tubs, showers, etc.).
- DigiTemp® Jr. **MUST** be installed in a dry enclosed area not susceptible to the weather elements such as rain, snow, ice, freezing temperature, direct sunlight or excessive heat.
- Keep work area clean, well-lighted, free of clutter and distractions, and accessible only by authorized personnel and workers.
- DigiTemp® Jr. valves and touchscreen display must be located in accessible and well lighted area for use, servicing, repair or replacement by authorized personnel.
- Valves Control Module is electrically powered. **ALWAYS** take proper precautions to recognize, evaluate, and control electricity hazards during installation, programming, use and service/maintenance.

NOTICE

Installation of DigiTemp® Jr. is performed by the owner using qualified and licensed trades such as plumbers and electricians, following all local, state, federal and other governmental requirements, and all building and construction codes and standards. Step-by-step installation instructions depend upon the application and the configuration of the building's water distribution system.

All installations require thorough flushing of all piping **BEFORE** installation, and testing for and eliminating all leaks before and after installation.

Connect inlets and outlet and check for leaks

To connect Power supply

- Press down on top of the front cover and pull out and down
- Lift the front cover up and away from the controller
- Loosen the screws at the front of the wiring cover
- Pull wiring cover straight out from the wiring chamber
- Connect live wire to terminal marked "L" and neutral wire to terminal marked "N" (see page 8)
- Re-assemble in reverse order.

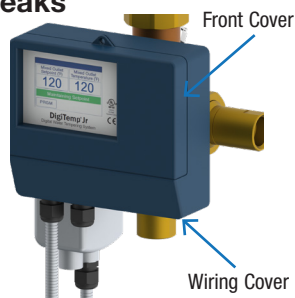

DigiTemp® Jr.

Control Unit Connections

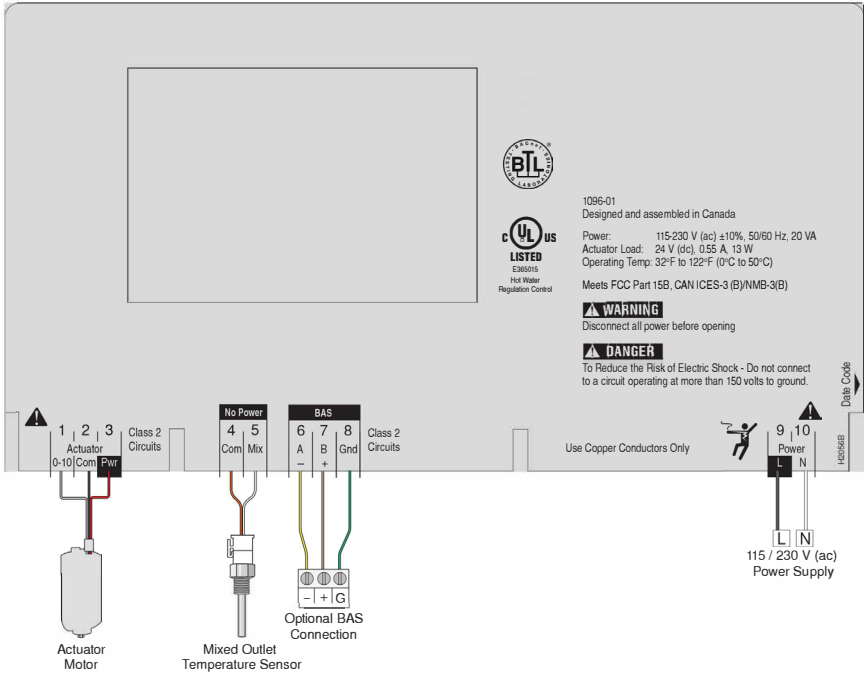

Set up and Programming

Turn on Power

1. Turn DigiTemp® Jr. power “ON” by turning on the main switch.
2. When powered up, the display will show a 70 second countdown timer and read:

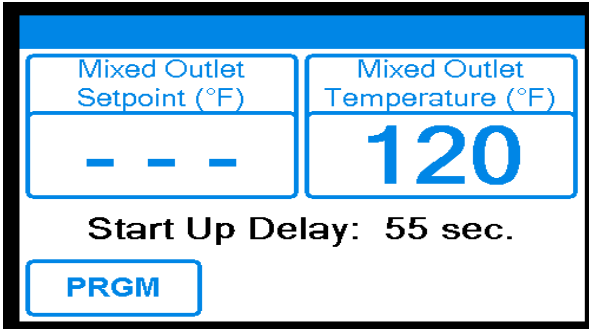

NOTICE

The control will begin mixing operations automatically after 70 seconds. During the 70 seconds the user may adjust setting and configure the control by touching the PRGM menu. If the user does nothing, the control will automatically route to the home screen after 70 seconds and begin normal operation. Efforts taken to program the device during the 70 second period will reset the 70 second clock.

3. To program the system press “**Programming**” button. The “programming screen will appear.

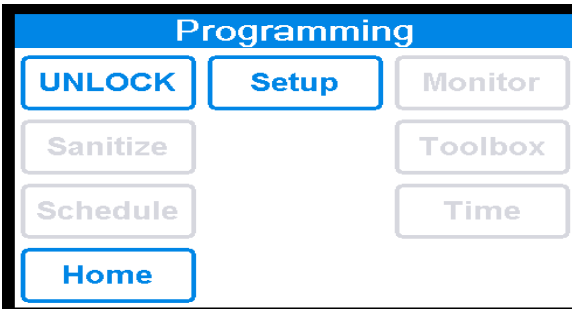

Set up and Programming

Create a passcode

DigiTemp® Jr. comes programmed with a factory default passcode (1017). For added security, and to help prevent unauthorized access, it is recommended that you create a unique 4 digit passcode as outlined below.

1. On the Programming Menu, touch the **UNLOCK** icon. The Unlock function screen will appear and you will be prompted to enter the passcode:

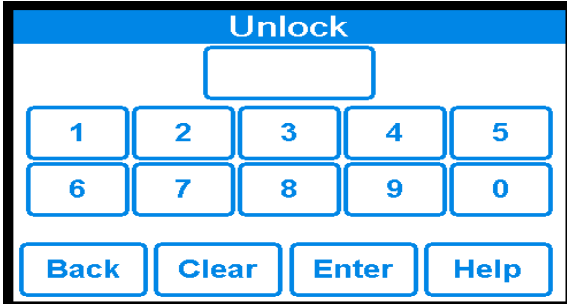

2. Creating your own passcode:

- To create your own passcode, enter the factory default passcode 1017 and press the **Help** icon in the lower right corner of the Unlock screen.
- Enter a new 4-digit passcode and touch the Enter icon (make sure to keep your new code in a secure place).
- Re-enter the new passcode and touch the Enter icon again to finalize the passcode change.

NOTICE

If you make a mistake when re-entering your new passcode and it does not match your first entry, **????** will appear.

Set up and Programming

Unlock the system

1. To unlock the system, on the Unlock screen, enter your new passcode, and touch the **Enter** icon.

NOTICE

If you need to clear your entry and start again, touch the **CLEAR** icon. If you want to go back to Programming Menu, touch the **BACK** icon.

If you did not set up your own passcode, you can enter the factory default passcode 1017.

2. When the passcode is entered, you will be directed to the liability and responsibility acceptance screen:

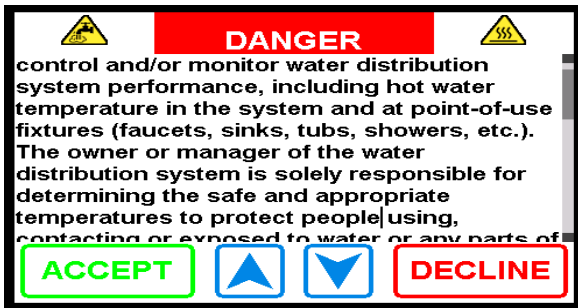

3. You must touch the **ACCEPT** icon to proceed to the Programming Menu and to use system functions.

Touching the **DECLINE** icon means you will not be able to change system settings and you accept all default settings (including the outlet water temperature set point of 140°F/160°C) as safe and appropriate for the water distribution system users and the facility. You will be returned to the “Programming” screen.

4. When you touch the **ACCEPT** icon, you will access the Programming Menu, which will appear as:

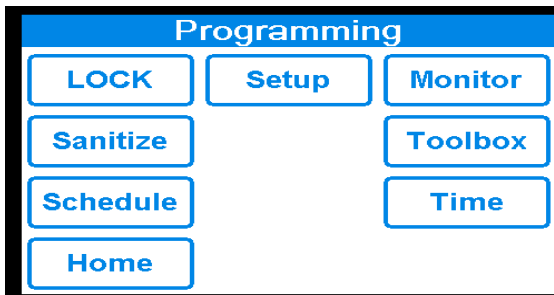

Set up and Programming

System Setup Menu

⚠ DANGER



The next steps involve selecting or adjusting the mixed outlet water temperature – the hot water temperature in the water distribution system and delivered to point-of-use fixtures (faucets, sinks, tubs, showers, etc.). The owner or manager of the water distribution system is solely responsible for determining the safe and appropriate temperatures to protect people using, contacting or exposed to water or any parts of the water distribution system from scalding, burning, thermal shock or other hazards, and to control water-borne bacteria in the system. Only qualified and authorized personnel who fully understand each function's operation, output and risks, should use Programming Menu functions. Always read and follow the User Guide & Instruction Manual.

Touch the **SETUP** icon which will direct you to the Setup Menu which will appear as:

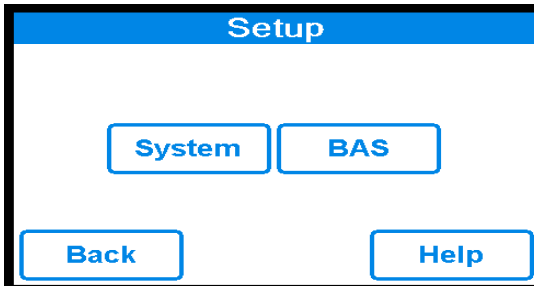

You can either setup the operation of the system by pressing the **System** button or configure the BAS connection by pressing **BAS** button. To setup operation of the system continue with the system setup. To turn on and configure the BAS connection, see page (19).

System Setup	
Mixed Outlet Setpoint	140 °F
Mixed Setback Offset	Off
High Temp. Alert Diff.	15 °F
Low Temp. Alert Diff.	15 °F

Set up and Programming

Note: Mixed Setback Offset is only available if a schedule is selected

Selecting and Setting Outlet Water Temperature Set-point:

⚠ WARNING

 **BEFORE** setting mixed outlet water temperature or electing default temperature, point-of-use mixing valves and/or temperature limiting devices **MUST** be installed at all fixtures (faucets, sinks, tubs, showers, etc.)



Set the safe, appropriate and desired outlet water temperature for your users, application and facility by pressing **mixed outlet setpoint** from system setup menu and using the **SLIDER** or **UP** and **DOWN** arrows until the selected temperature is displayed. Press **ACCEPT**

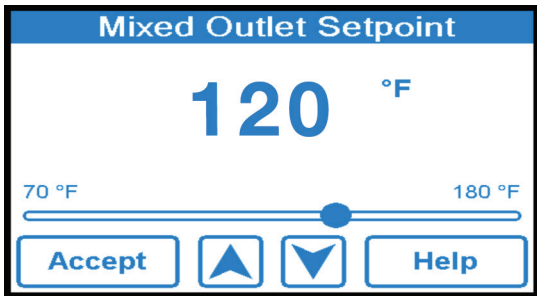

The owner or manager of the water distribution system is solely responsible for determining the safe and appropriate temperatures to protect people using, contacting or exposed to water or any parts of the water distribution system from scalding, burning, thermal shock or other hazards, and to control water-borne bacteria in the system.

Once the desired temperature is selected, press the **ACCEPT** icon to apply the setting. You will be returned to the System Setup Menu screen.

Set up and Programming

To set mixed setback offset (to set temperature lower during unoccupied period) press word **mixed setback offset** from the **system setup** menu and press **off** and **ACCEPT**.

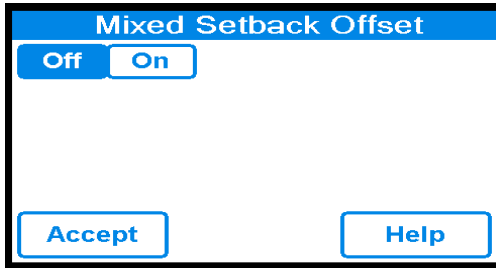

To set **Mixed Setback Offset** press **On** and **ACCEPT**. Temperature can be changed by **SLIDER** icon or by touching the **UP** or **DOWN** arrows.

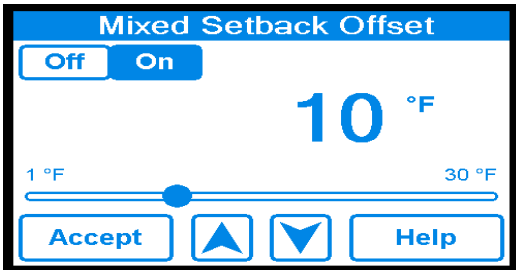

To change high temperature alert differential, press word **high temp. alert diff.** from the **system setup** menu. High temperature alert differential can be changed by **SLIDER** icon or by **UP** or **DOWN** arrows and then pressing **ACCEPT**.

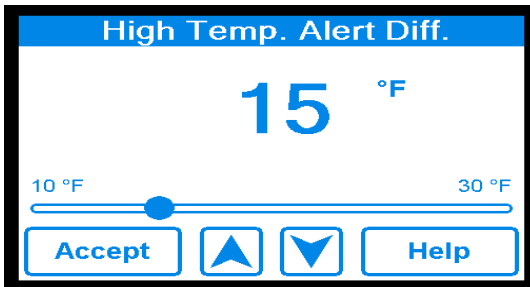

Set up and Programming

To change low temperature alert differential, press word **low temp. alert diff.** from the **system setup** menu. **Low temperature alert differential** can be changed by **SLIDER** icon or by **UP** or **DOWN** arrows and then pressing **ACCEPT**.

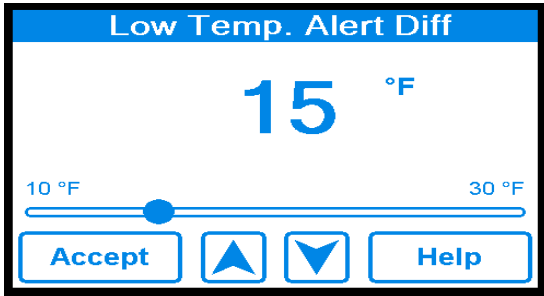

If you are finished at this time, the system will return to a locked state if not touched for 70 seconds.

Or, touch the **BACK** icon twice to return to the “Programming” menu, then press **LOCK**. When the system is locked, the “Programming” menu will now display the **UNLOCK** icon, as shown below:

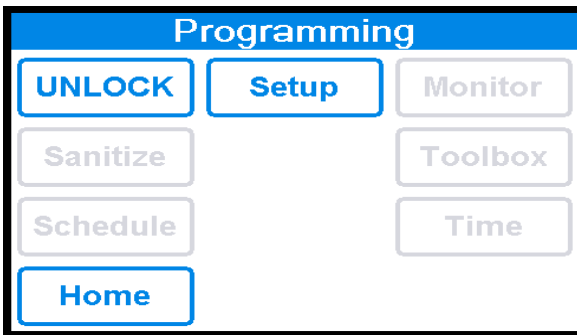

Configuring the Control for BAS communication

1. Configure the control to communicate using the “User Interface-BAS Menu” information within this manual and/or the “BAS Integration Manual.”

Introduction

DigiTemp® Jr. can communicate with a Building Automation System (BAS) using BACnet® MS/TP and Modbus RTU. This manual provides information about the measurements, control parameters, and error messages which can be assessed by building automation and/or management systems that use BACnet® MS/TP or Modbus RTU communication. DigiTemp® Jr. can be configured to provide remote monitoring and remote temperature set point control.

BAS Connection Procedure

⚠ DANGER



BEFORE attempting to connect BAS, a certified and qualified electrician MUST fully de-energize and disconnect all electrical power from DigiTemp.

Perform required LOCK OUT/TAG OUT procedures.



BAS connection MUST be performed by certified and qualified electrician.

1. After completely de-energizing and disconnecting all power from DigiTemp® Jr. and performing required LOCK OUT/TAG OUT, carefully open the DigiTemp control module to reveal BAS hook up terminals.



As an additional safety check, once the box is open, confirm that the unit is de-energized by measuring the AC voltage across the “L” and “N” terminals (9 and 10 respectively) using the voltmeter. Alternatively, use a voltage detector to confirm that the unit is NOT energized.

2. With the control module open, the BAS connections are visible on bottom side as shown below.

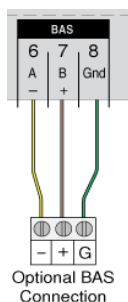

DigiTemp® Jr. BAS Integration Manual

3. The control module has a knock-out plug hole. Knock-out the plug hole and run the BAS wire to the controller.

NOTICE

A grommet or wire protector should be used to protect the wire from being damaged by the enclosure hole opening.

4. If connecting the controller to a BACnet MSTP system run the A(-), B(+), GND terminals from the nearest BAS system component and connect to terminals 6, 7, and 8 (-, +, Gnd) of DigiTemp Jr. control Module 1096.

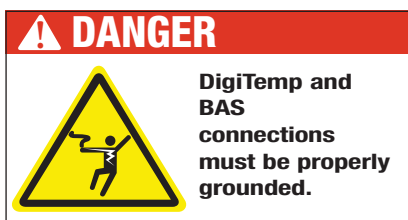

DO NOT ground to the enclosure. Ground ("Gnd") terminal must be connected to terminal "A" marked "Gnd".

5. If connecting the controller to a Modbus BAS system system run the A(-), B(+), GND terminals from the nearest BAS system component and connect to terminals 6, 7, and 8 (-, +, Gnd) of the DigiTemp Jr controller.



DO NOT ground to the enclosure. Ground ("Gnd") terminal must be connected to terminal "A" marked "Gnd".

BAS® Settings in the DigiTemp® Jr. Control Module Menu

When the unit powers up it displays the warning message will be shown until 70 seconds has elapsed. After 70 seconds the control will automatically redirect to the "Home" screen. The settings menu can be accessed prior to the time elapsing by touching anywhere on the screen.

From the home screen touch the PRGM icon to access the "Programming" menu.

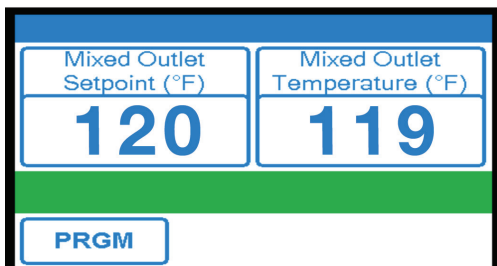

DigiTemp® Jr. BAS Integration Manual

From within the “Programming” menu (shown below) only the **Home**, **Setup** and **UNLOCK** icons are active until the control is in the unlocked state. Note: After 70 seconds of inactivity the control automatically locks and returns to the home screen.

To unlock the control select the **UNLOCK** icon from within the “Programming” menu

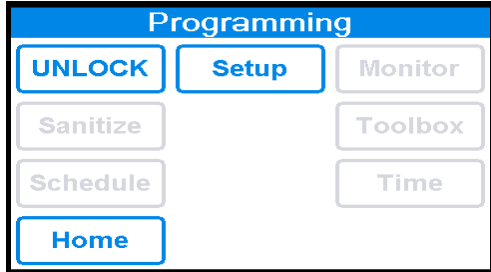

Unlock the control by entering your password and selecting the **ENTER** icon. If you have not yet set your password, please refer to page (10) for password setup. If the wrong code was entered select **Clear** to try again. Note: the **ENTER** icon will only work if the correct code is entered. Once unlocked, the control automatically redirects to the “Programming” menu but this time the **UNLOCK** icon will appear as **LOCK** icon, indicating that the control is unlocked, and the other icons (**SETUP**, **MONITOR**, **SANITIZE**, **TOOLBOX**, **SCHEDULE**, **Wi-Fi**, **AND TIME**) will now be active.

Select the **setup** icon from within the “Programming” menu to access the “Setup” menu shown below.

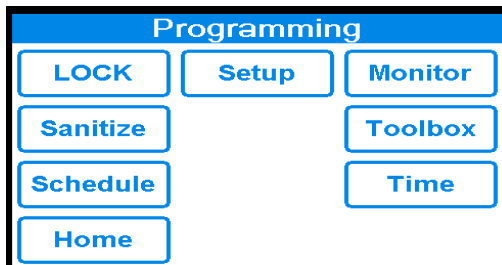

DigiTemp® Jr. BAS Integration Manual

Select the **BAS** icon from within the “Setup” menu to access the “Building Automation” menu shown below.

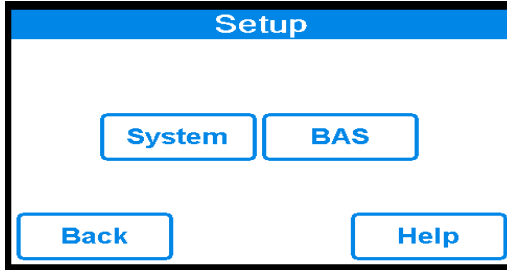

The default “BAS Type” is “NONE” as shown below.

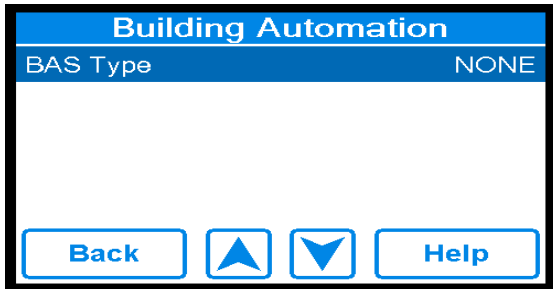

To change this setting press the “BAS Type” and adjustment screen will appear (as shown below).

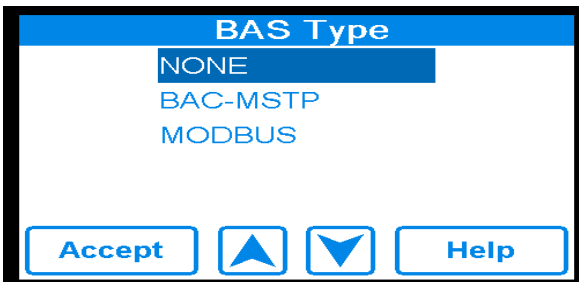

Depress the **UP** and **DOWN** arrows to scroll through the BAS types and depress the icon to configure the control to the highlighted type and return to the “Building Automation” menu. Note: depending on the BAS Type selected, various user configurable items will now appear within the “Building Automation” menu. A table of the user definable items is shown below.

DigiTemp® Jr. BAS Integration Manual

The Building Automation “BAS Menu” shows default settings for each of the communication protocols supported by this control (BACnet® MSTP and Modbus).

BACnet Specific Settings

Building Automation	
BAS Type	BAC-MSTP
BACnet Device ID	0000001
BAC-MSTP Address	001
BACNet Baud Rate	9600

To change the BACnet Device ID, press the words **BACnet Device ID**, enter the device ID number, and press **ACCEPT**.

BACnet Device ID				
0000001				
1	2	3	4	5
6	7	8	9	0
Accept		Clear		Help

To change the BAC-MSTP Address, press the words **BAC-MSTP Address**, enter the address, and press **ACCEPT**.

BAC-MSTP Address				
001				
1	2	3	4	5
6	7	8	9	0
Accept		Clear		Help

DigiTemp® Jr. BAS Integration Manual

To change the BACNet baud rate, press the words **Bacnet Baud Rate**, select the baud rate using the **UP** and **DOWN** arrows, and press **ACCEPT**

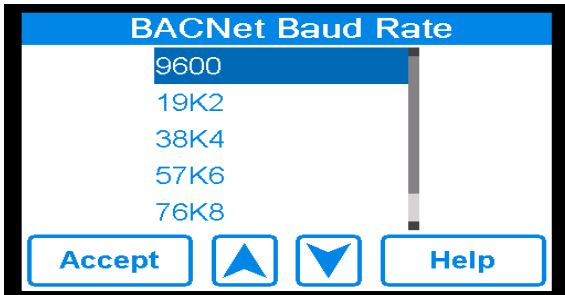

BACnet® Protocol Implementation Statement (PICS)

Vendor Name: PVI

Vendor ID: 601

Product Name: DigiTemp® Jr.

Product Model Number: 1096-03 (controller)

Application Software Version: J1279

Firmware Revision: 1.0.2

BACnet Protocol Revision: 12

Product Description:

The DigiTemp Jr is a 3-way mixing valve digital controller designed to control the delivery of tempered water to plumbing fittings. It is intended to support scald prevention valves in a building system by complying with ASSE 1017. It uses Proportional-Integral (PI) logic to accurately maintain a target temperature by mixing hot and cold temperature water sources.



DigiTemp Jr. provides user-directed control and monitoring of water distribution systems. It is the user's responsibility to select and maintain water temperatures and pressures that are safe and appropriate for the water system users, guests and facility. DigiTemp Jr's Sanitization mode is intended for use as part of a user-directed, controlled and supervised protocol that has been safely and properly designed. It is recommended to install DigiTemp Jr. as part of a domestic hot water distribution system that complies with local codes, and includes downstream mixing valves compliant to ASSE 1070 that are installed near point of use. Always read and follow User Guide & Instruction Manual and all product warnings and labels, and comply with all governmental and safety requirements.

DigiTemp® Jr. BAS Integration Manual

BAS Menu

BACnet Standardized Device Profile (ANNEX L)
BACnet Application Specific Controller (B-ASC)

Supported BIBBs (Annex K)	Name
DS-RP-B	Data Sharing-ReadProperty-B
DS-RPM-B	Data Sharing-ReadPropertyMultiple-B
DS-WP-B	Data Sharing-WriteProperty-B
DM-DDB-B	Device Management-Dynamic Device Binding-B
DM-DOB-B	Device Management-Dynamic Object Binding-B
DM-DCC-B	Device Management-Device Communication Control-B

Note: Device communication control password is "PVI1017".

Segmentation Capability	Supported
Able to transmit segmented messages	No
Able to receive segmented messages	No

Standard Object Types Supported	Creatable	Deletable
Analog Input	No	No
Analog Value	No	No
Binary Output	No	No

Data Link Layer Options	Supported
MS/TP master (Clause 9)	Yes
BACnet IP (Annex J)	No

Device Address Binding	Supported
Static Device Address Binding	No

Network Security Options	Supported
Non-Secure Device	Yes

Character Set	Supported
ANSI X3.4	Yes

DigiTemp® Jr. BAS Integration Manual

BACnet® Analog Parameters

Objective Identifier	Objective Type	Objective Name	Present Value	Status Flags	Description	Range/Value	Event State	Reliability	Out of Service	Units
0	analog-Input	Mixed Outlet Temperature		FFF(F/T)	Mixed Outlet Temperature	0 - 266	Normal	0, 1, 4, 5	FALSE	°F (64)
1	analog-Input	Valve Position		FFF(F/T)	Analog signal provided to actuator	0 - 10	Normal	0	FALSE	Volts (5)
2	analog-Input	Mixed Outlet High		FFF(F/T)	Highest recorded mixed outlet temperature	0 - 266	Normal	0	FALSE	°F (64)
3	analog-Input	Mixed Outlet Low		FFF(F/T)	Lowest recorded mixed outlet temperature	0 - 266	Normal	0	FALSE	°F (64)
4	analog-Input	High Temperature Alert Differential		FFF(F/T)	High Temperature Alert Differential	10 - 30	Normal	0	FALSE	°F (64)
5	analog-Input	Low Temperature Alert Differential		FFF(F/T)	Low Temperature Alert Differential	10 - 30	Normal	0	FALSE	°F (64)
6	analog-Input	High Temperature Alert Count		FFF(F/T)	Number of High Temperature Alerts	0 - 65535	Normal	0	FALSE	Number (95)
7	analog-Input	Low Temperature Alert Count		FFF(F/T)	Number of Low Temperature Alerts	0 - 65535	Normal	0	FALSE	Number (95)
8	analog-Input	Error Code		FFF(F/T)	Numerical error code (see error code table)	1 to 4	Normal	0	FALSE	Number (95)
Others	analog-Input	ERROR	ERROR	ERROR	Communication error	ERROR	ERROR	ERROR		

Analog Valve Objects

Objective Identifier	Objective Type	Objective Name	Present Value	Status Flags	Description	Range/Value	Event State	Out of Service	Units
0	analog-value	Mixed Outlet Setpoint		FFF(F/T)	Target Temperature	70 - 180	Normal	true to false	°F (64)
Other	analog-value	ERROR	ERROR	ERROR	Communication error	ERROR	ERROR	ERROR	

Modbus Specific Settings

Building Automation

BAS Type	MODBUS
Modbus Address	1
Modbus Data Type	RTU
Modbus Baud Rate	9600
Modbus Parity	Even

Back

▲

▼

Help

DigiTemp® Jr. BAS Integration Manual

To enter the Modbus address, press the words **Modbus Address** from **Building Automation** menu and enter Modbus address and **ACCEPT**.

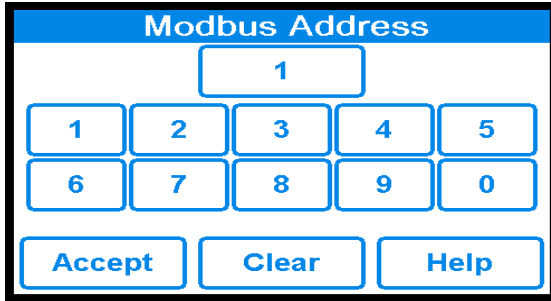

The screen displays the title "Modbus Address" in a blue header. Below the header is a single input field containing the number "1". Underneath the input field is a numeric keypad with buttons for digits 1 through 0. At the bottom of the screen are three buttons: "Accept", "Clear", and "Help".

To select, press the words **Modbus Data Type** from Building Automation menu and enter desired data type and **ACCEPT**.

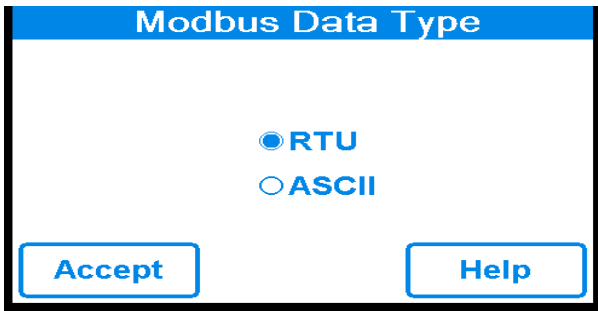

The screen displays the title "Modbus Data Type" in a blue header. Below the header, there are two radio button options: "RTU" (which is selected) and "ASCII". At the bottom of the screen are two buttons: "Accept" and "Help".

To select Modbus baud rate, press the words **Modbus Baud Rate** from **Building Automation** menu. Select desired Modbus Baud Rate by **UP** or **DOWN** arrows and **ACCEPT**.

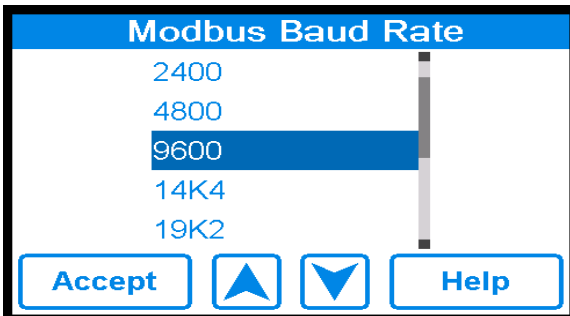

The screen displays the title "Modbus Baud Rate" in a blue header. Below the header is a list of baud rate options: 2400, 4800, 9600, 14K4, and 19K2. The option "9600" is highlighted with a blue bar. To the right of the list is a vertical scrollbar. At the bottom of the screen are four buttons: "Accept", an up arrow, a down arrow, and "Help".

DigiTemp® Jr. BAS Integration Manual

To enter the modbus parity, press the words **Modbus Parity** from Building Automation menu and select desired modbus parity by **UP** or **DOWN** and **ACCEPT**.

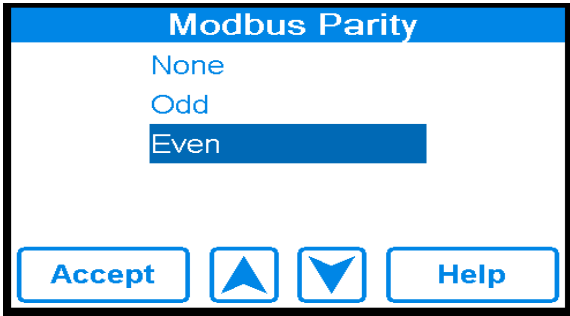

Modbus® Specifications

Communication Protocol	Modbus over RS485
Physical Layer	RS485 Two-Wire plus Signal Ground
Baud Rate	2400, 9600, 19200, 57.6k, 115k)
	(default 19200 bps)
Recommended Cable	18 AWG Shielded Twisted-Pair (STP)
Transmission Mode	RTU or ACSII (default RTU)
Maximum Cable Length	Without terminating resistors
	- 115,000 baud --> 177 m (580 ft)
	- 57,600 baud --> 353 m (1,158 ft)
	- 19,200 baud --> 1,000 m (3,280 ft)
	- 9,600 baud --> 1,000 m (3,280 ft)
	- 2,400 baud --> 1,000 m (3,280 ft)
	With 2 x 120 Ohm resistors
	- 115,000 baud --> 1,000 m (3,280 ft)
	- 57,600 baud --> 1,000 m (3,280 ft)
	- 19,200 baud --> 1,000 m (3,280 ft)
	- 9,600 baud --> 1,000 m (3,280 ft)
	- 2,400 baud --> 1,000 m (3,280 ft)
Start Bit	1 Bit
Data Length	8 Bits for RTU Mode 7 Bits for ACSII Mode
Parity	None (2 Stop Bits) Even (1 Stop Bit) Odd (1 Stop Bit) (default Even)
Addressing	1 to 247 (default 1)

DigiTemp® Jr. BAS Integration Manual

Modbus® Parameters

Read= R

Read/Write= R/W

Analog Input Objects

Parameter	Read/Write	Units	Range	Type	Register	Format
Holding Registers						
Mixed Outlet Setpoint	R/W	°F	70 to 80°F	Holding	1	U16
Input Registers						
Mixed Outlet Temperature	R	°F	0 to 266°F	Input	1	U16
Valve Position	R	Vdc X 10	0 to 100	Input	2	U16
Mixed Outlet High	R	°F	0 to 266°F	Input	3	U16
Mixed Outlet Low	R	°F	0 to 266°F	Input	4	U16
High Temperature Alert Differential	R	°F	10 to 30°F	Input	5	U16
Low Temperature Alert Differential	R	°F	10 to 30°F	Input	6	U16
High Temperature Alert Count	R	Counts	0 to 65535	Input	7	U16
Low Temperature Alert Count	R	Counts	0 to 65535	Input	8	U16
Error Code	R	Enum	Numerical Error Code (See Error Code List)	Input	9	U16
Model	R	Num	1096	Input	10	U16
Firmware Revision	R	Num	SVN Revision	Input	11	U16

Modbus® Troubleshooting

If there is no communication, check the following:

- Check that the polarity on the Modbus® + and - terminals is correct
- Check that the Modbus® GDN terminal is securely connected.
- Check that the Baud Rate on both devices is the same.

If the communication is intermittent, check the following:

- Check that the communication cable is twisted pair type.
- Reliable communication depends on the cable length & Baud Rate used.
Long cable length may require a lower baud rate.

Error Codes



Code	Description
1	NVM Error
2	Faulty Mixed Outlet temperature sensor
3	High Temperature Alert
4	Low Temperature Alert

Sanitization

The Sanitization function produces high water temperatures and is intended ONLY for use as part of a user-directed, controlled and supervised thermal eradication protocol that has been safely and properly designed to help limit water-borne bacteria within the tempered water distribution system. The instructions contained in this Manual for the Sanitization function are not intended to be a thermal eradication protocol.

Selecting, directing, and controlling a safe and properly designed thermal eradication protocol is the sole responsibility of the people who own, manage or control the water distribution system. It is their responsibility to protect water distribution end-users, facility employees or contractors, and bystanders from scalding, burning, thermal shock, or other hazards from possible exposure to water or any parts of the water distribution system during Sanitization and cool

⚠ DANGER

The Sanitization function produces high temperature water at all point-of-use fixtures (faucets, sinks, tubs, showers, etc.). Only qualified and authorized personnel who fully understand the function's operation, output and risks, should use the Sanitization function, and only as part of and in compliance with, a thermal eradication protocol safely and properly designed by the owner or manager of the water distribution system. The owner or manager of the water distribution system has sole responsibility to protect end-users, facility employees or contractors, personnel performing the Sanitization, and bystanders from scalding, burning, thermal shock, or other hazards from possible exposure to water or any parts of the water distribution system during Sanitization and cool down period, until system water returns to a safe and proper outlet water temperature set point. Always read and follow the User Guide & Instruction Manual.

1. On the Programming Menu Touch the **Sanitize** icon, which will direct you to the responsibility and liability acceptance page:

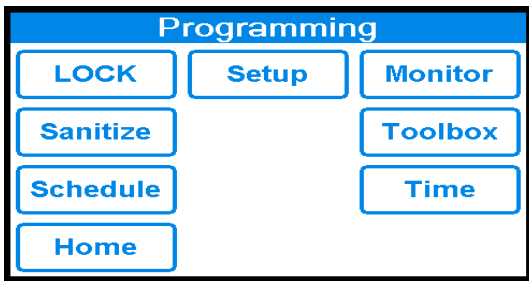

2. You must touch the **ACCEPT** icon to proceed with the Sanitization function. Touching the **DECLINE** icon means you will be unable to utilize the Sanitization function and you will be returned to the "Programming" Menu page. When you touch the **ACCEPT** icon, you will be directed to the Sanitization menu screen.

Sanitization

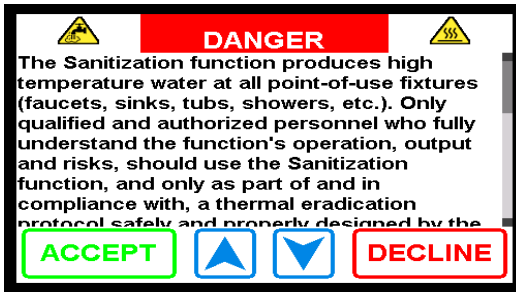

3. Select the sanitization set point by pressing the word **Temperature** from **Sanitization** menu.

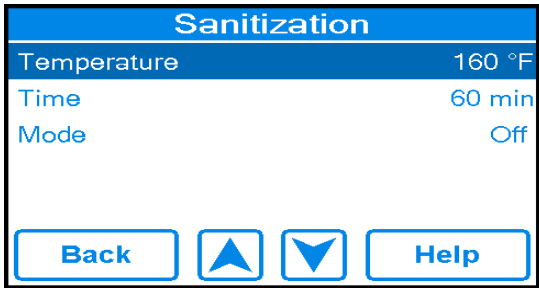

4. Using the slide bar or up and down arrows select the desired outlet water temperature. Touch the **ACCEPT** icon to confirm the adjustment.

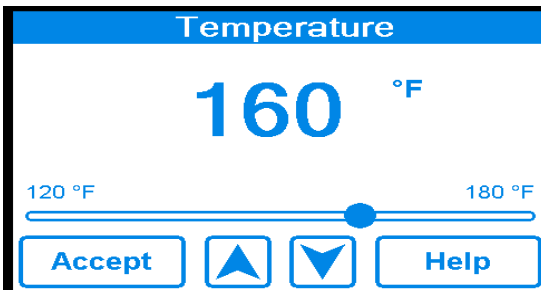

Sanitization

5. Next, Select the run time by touching word **Time** from the **Sanitization** menu.



6. Using the slide bar or up and down arrows select the desired run time. Touch the **ACCEPT** icon to confirm the adjustment.



WARNING

BEFORE starting the Sanitization function, make sure you are in full compliance with a safely and properly designed thermal eradication protocol, protecting end-users, facility employees or contractors, personnel performing the Sanitization, and bystanders from scalding, burning, thermal shock, or other hazards.

7. To start the sanitization function, select the word **Mode** from the **Sanitization** menu.

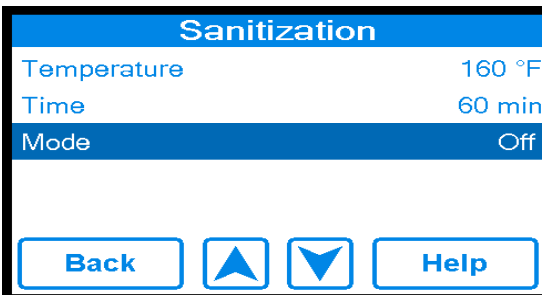

Sanitization

8. Once in the Mode menu, toggle to the **ON** radio button and then select **ACCEPT**.

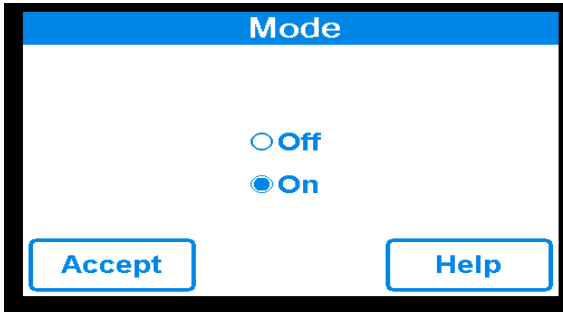

The Sanitization Mode is now fully functional. Note: The HOME screen will indicate you are Sanitizing the water delivery system and indicate Mixed Outlet Temperature.

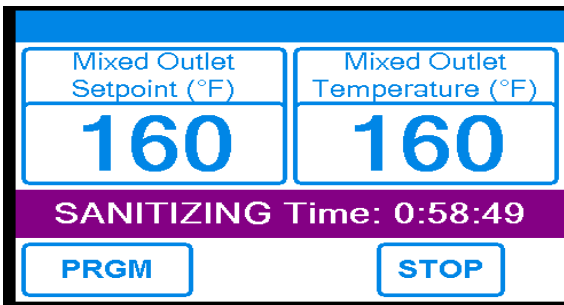

9. After Sanitization Mode has completed (user selected run time has elapsed), DigiTemp® Jr. will go into a Cool Down Mode to return to the Mixed Outlet temperature prior to returning to normal operation.

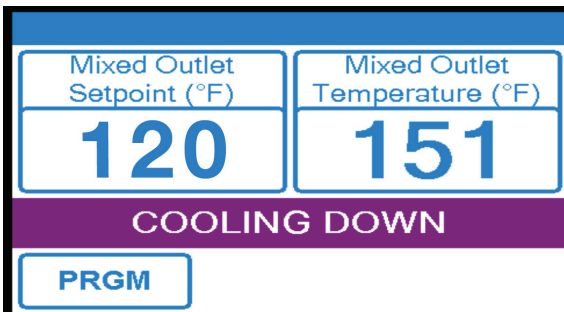

Time Function

Touching the **TIME** icon on the “Programming” Menu will allow access to the Time Function:

To turn on the **Date & Time** functionality, press the word **Date & Time** from the Time Options menu.

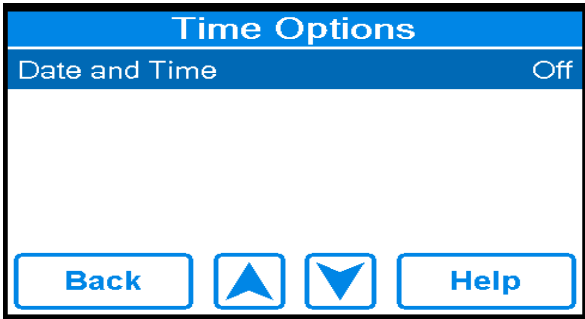

Once in the **Date and Time** menu, toggle to the **ON** radio button and then select **ACCEPT**.

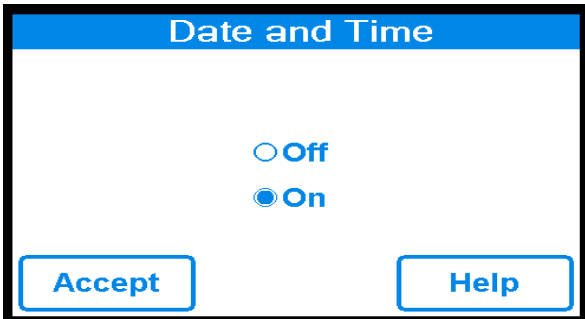

To set date and time, press the word **Set Date and Time** from **Time Options** menu.

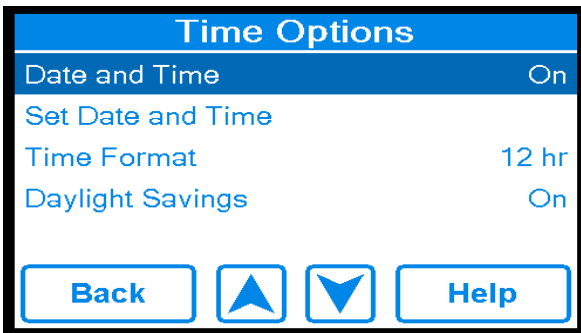

Time Function

To set date and time, select month, date, year, hour, minute and AM/PM icon at a time and change with **UP** or **DOWN** arrows then select **ACCEPT**.

The screenshot shows a menu titled "Set Date and Time" with a blue header. Below the header are six buttons arranged in two rows of three. The first row contains "Jan", "04", and "2018". The second row contains "5", "03", and "PM". At the bottom of the menu are four buttons: "Accept", an upward-pointing arrow, a downward-pointing arrow, and "Help".

To select time format, press the word **Time Format** from the **Time Option** menu

The screenshot shows a menu titled "Time Options" with a blue header. Below the header is a list of options with their current settings on the right: "Date and Time" (On), "Set Date and Time", "Time Format" (12 hr), and "Daylight Savings" (On). At the bottom of the menu are four buttons: "Back", an upward-pointing arrow, a downward-pointing arrow, and "Help".

To select time format, toggle to the **12hr** or **24hr** radio button and select **ACCEPT**

The screenshot shows a menu titled "Time Format" with a blue header. Below the header are two radio button options: "12 hr" (which is selected) and "24 hr". At the bottom of the menu are two buttons: "Accept" and "Help".

Time Function

To select daylight savings time, press the word **Daylight Savings** from the **Time Options** menu

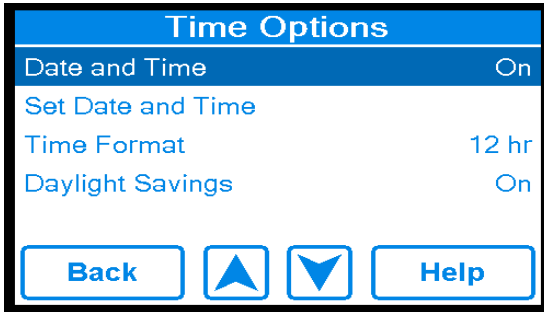

Once in the **Daylight Savings** menu, toggle to **On** radio button and select **ACCEPT**.

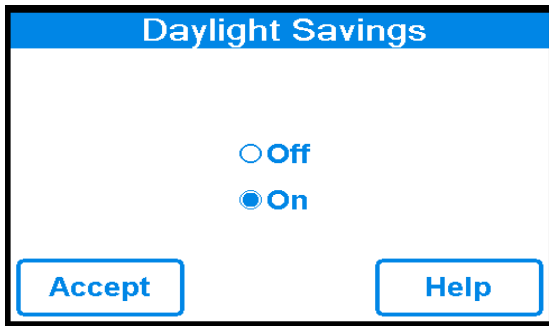

Schedule Function

Touching the **SCHEDULE** icon on the “Programming” Menu will allow access to the schedule Function:

To turn on **schedule**, press the word **Schedule** from the **Schedule** menu

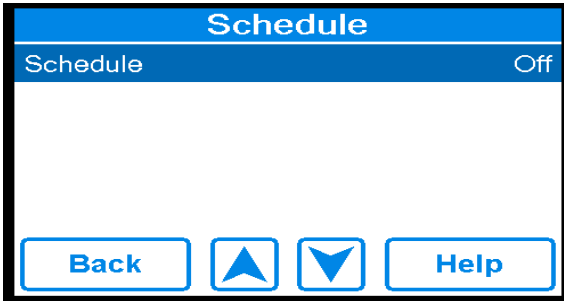

Once in the schedule menu, toggle to the **On** radio button and then select **Accept**.

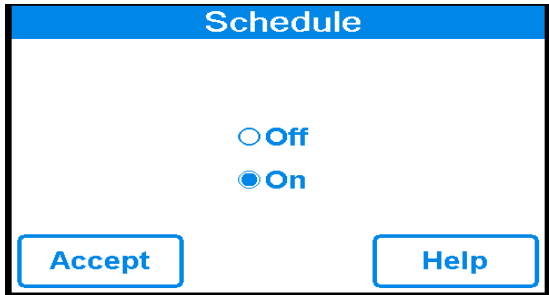

To select the type, press the word **Type** from the **Schedule** menu.

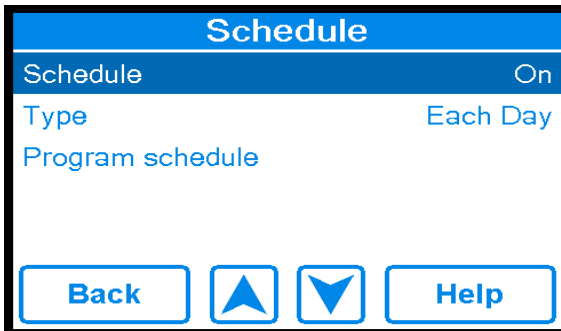

Schedule Function

Once in the **Type** menu, toggle to the **Each Day** radio button and then select **ACCEPT**.

The screenshot shows a menu titled "Type" with a blue header. Below the header, there are two radio button options: "All Days" (unselected) and "Each Day" (selected). At the bottom of the menu, there are two buttons: "Accept" on the left and "Help" on the right.

To program **Each day**, press the word **Program Schedule** from the **Schedule** menu.

The screenshot shows a menu titled "Schedule" with a blue header. Below the header, there is a list of options: "Schedule" (with "On" to its right), "Type" (with "Each Day" to its right), and "Program schedule". At the bottom of the menu, there are four buttons: "Back", an up arrow, a down arrow, and "Help".

Schedule **Normal** and **Savings** time and then select **ACCEPT**.

The screenshot shows a menu titled "Schedule" with a blue header. Below the header, there is a grid for selecting days and times. The days are listed in a row: Mon, Tue, Wed, Thr, Fri, Sat, Sun. Below the days, there are two rows for "Normal" and "Savings" times. The "Normal" row has "06" selected in the first column, "00" in the second, "AM" in the third, and "Skip" in the fourth. The "Savings" row has "10" in the first column, "00" in the second, "PM" in the third, and "Skip" in the fourth. At the bottom of the menu, there are four buttons: "Accept", an up arrow, a down arrow, and "Help".

Schedule Function

If prefer all day toggle to the all day radio button and then select **ACCEPT**.

Type

All Days

Each Day

Accept Help

To program **All day**, press the word **Program Schedule** from the **Schedule** menu.

Schedule On

Type Each Day

Program schedule

Back [Up Arrow] [Down Arrow] Help

Schedule **Normal & Savings** time and then select **ACCEPT**

Schedule

All Days

Normal 06 00 AM Skip

Savings 10 00 PM Skip

Accept [Up Arrow] [Down Arrow] Help

Monitor Function

Touching the **MONITOR** icon on the “Programming” Menu will allow access to the Monitor Function

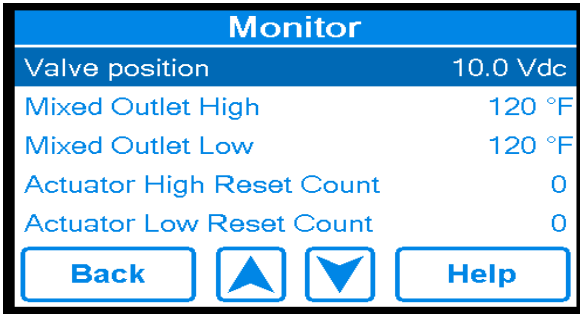

For mixed outlet high, press the words **Mixed Outlet High** from the Monitor menu then you can **ACCEPT** or **RESET** to zero

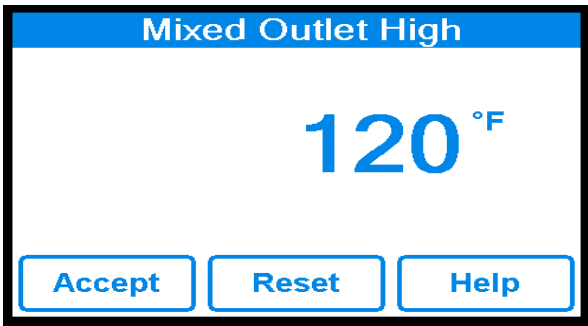

For mixed outlet low, press the words **Mixed Outlet Low** from the **Monitor** menu then you can **ACCEPT** or **RESET** to zero

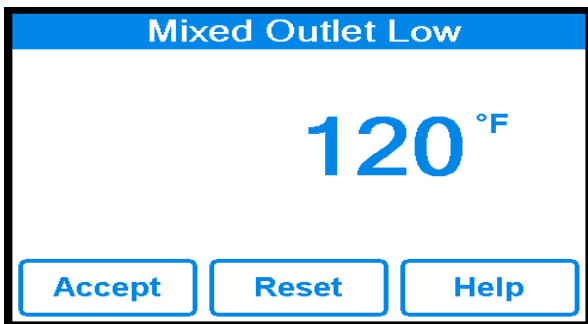

Monitor Function

To monitor actuator high reset count, press the words **Actuator High Reset Count** from the **Monitor** menu then you can **ACCEPT** or **RESET** to zero

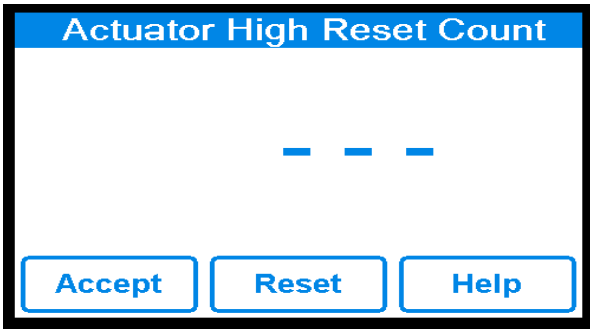

To monitor **actuator low reset** count, press the words **Actuator Low Reset Count** from the **Monitor** menu then you can **ACCEPT** or **RESET** to zero

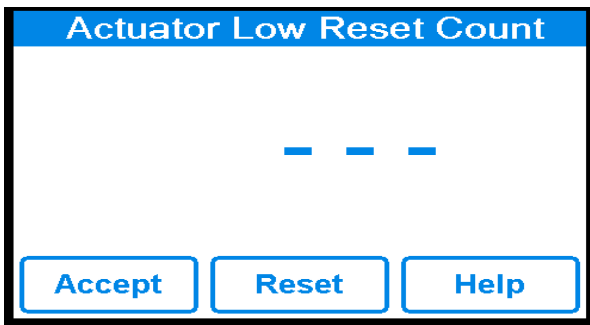

To select reset all. Scroll down through the **Monitor** menu press the words **Reset All**

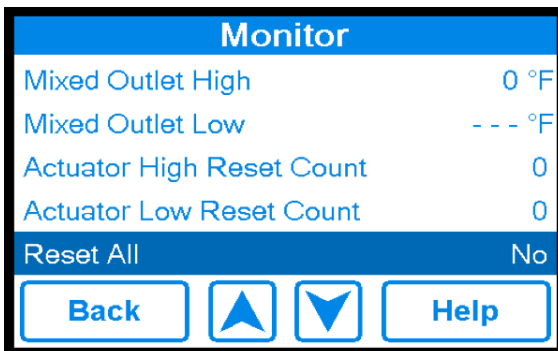

Toolbox Function

Touching the **TOOLBOX** icon on the “Programming” Menu will allow access to the Toolbox Function. Scroll through the Toolbox menu using the **UP** and **DOWN** buttons to access each option.

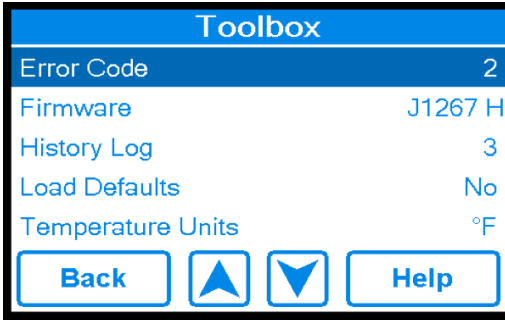

To find out error code press the words **Error Code** from the **Toolbox** menu. after select **Back**

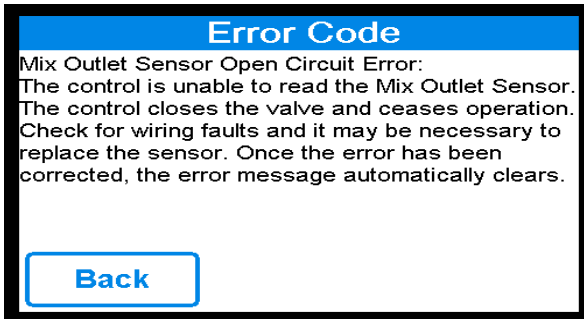

To view the control type information for your controls press the word **Firmware** from the **Toolbox** menu and then select **Back**



Toolbox Function

To access the history log, press words **History Log** from the **Toolbox** menu then select **Back**

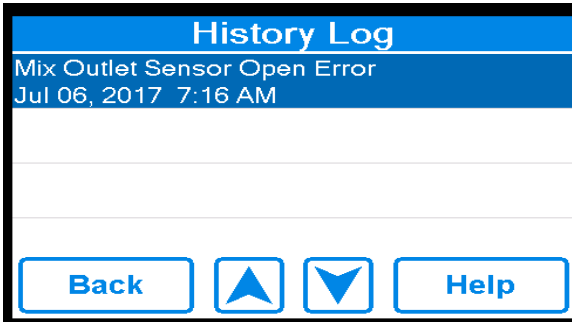

To select load default, press the words **Load Defaults** from the **Toolbox** menu. Toggle radio button to **No** for no load or **Yes** for Load Defaults and select **ACCEPT**

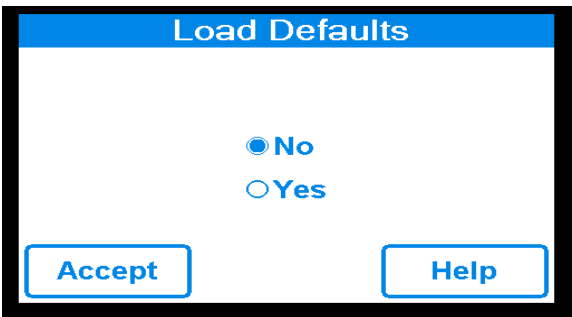

To select load temperature units, press the words **Temperature Units** from the **Toolbox** menu. Toggle radio button to **F** for Fahrenheit or **C** for Celsius and select **ACCEPT**

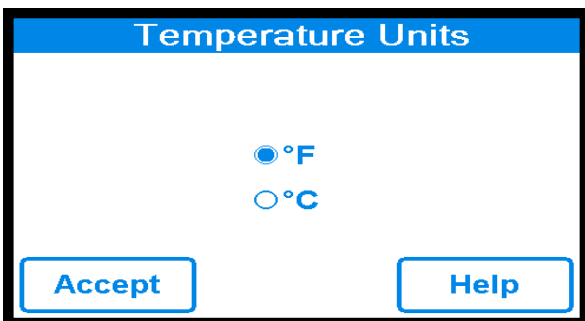

Toolbox Function

To adjust the screen brightness, press the words **Screen Brightness** from the **Toolbox** menu. Move the slider or use **Up** or **Down** arrows to adjust the brightness and select **ACCEPT**

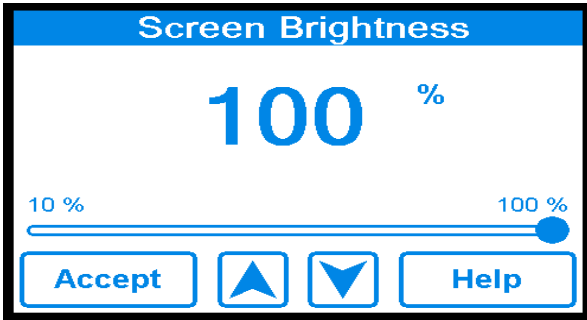

To clean dirty screen, press the words **Clean Screen** on the **Toolbox** menu. Toggle radio button to **Yes** to lock the screen to clean or **No** to keep it unlock and then select **ACCEPT**.

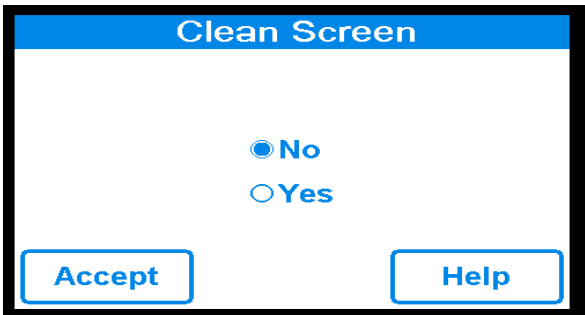
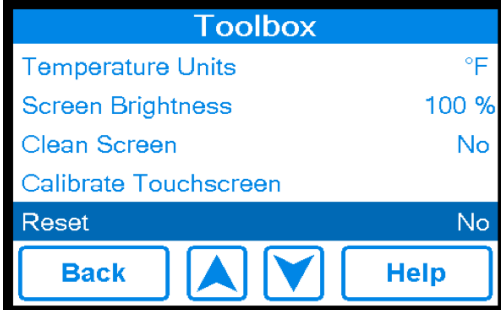

Toolbox Function

To calibrate the touchscreen, press the words **Calibrate Touchscreen** on the **Toolbox** menu. Press each circle to calibrate the touch screen.

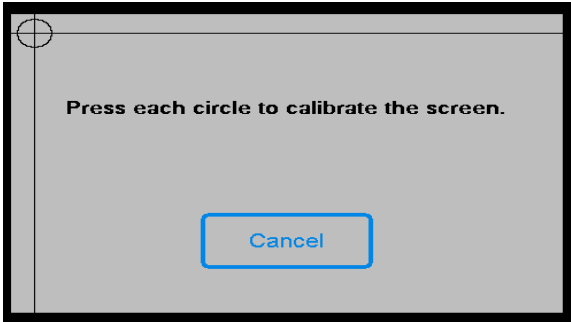

To reset all, press the word **Reset** on the **Toolbox** menu. Toggle the radio button to **Yes** or toggle to **No** to leave the current settings

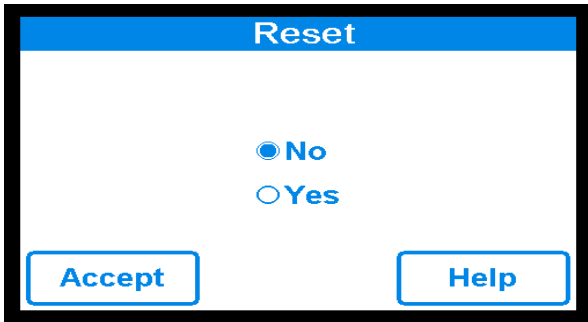

Troubleshooting

Problem: Outlet temperature is below set point temperature and/or the low temperature alarm has been activated

Solution:

1. Depending on the heating plant plumbing and location, it may take several minutes for the hot water to reach the unit. Ensure that you have allowed enough time (5 minutes) for the system to come up to temperature.
2. On the Home screen, check the “Mixed Outlet Set point” and the hot water supply temperature. The hot water supply temperature needs to be above the set-point or the unit will not be able to reach the set-point.
3. If the hot water supply temperature is BELOW the “Mixed Outlet Set point”
 - a. Raise the hot water supply temperature at least 2°F (1°C) above the mixed outlet set-point temperature.
 - b. Ensure that the hot water is flowing.
 - c. Check the hot water source set-point temperature and ensure that the hot supply line has no obstructions or closed valves restricting flow to the DigiTemp.
4. If the hot water supply temperature is ABOVE the “Mixed Outlet Set point”, there are no obstructions preventing hot water from reaching the unit, and there is sufficient flow through the unit, reset the control by pressing the PRGM icon to access the “Programming” menu. Unlock the control and then select the “Toolbox” to navigate to the “Toolbox” menu. From within the “Toolbox” menu use down arrow to highlight “Reset” then press enter. This will access “Reset” menu. Press the “YES” and then press accept. The controller will reset and begin a start up sequence.

Note: Alternately, the control can be reset by opening and closing the circuit breaker switch and waiting 70 seconds to resume normal operation.



Always use proper precautions when accessing circuit breaker box.

5. If problem persists after conducting the above outlined problem solving procedures, contact Watts Heating and Hot Water Solutions Customer Care Department. See contact details on the cover of this manual.

Troubleshooting

Problem: Outlet temperature above set point

Solution:

1. Ensure flow is above the minimum rated flow by opening the hot water valve on two to four fixtures being supplied with tempered water from the panel.
2. Ensure that the cold supply is flowing.
3. Check cold water temperature and ensure that it is lower than the set point temperature and supply line has no obstructions or closed valves restricting flow to the DigiTemp.
4. Unlock the control and then select the "Toolbox" to navigate to the "Toolbox" menu. From within the "Toolbox" menu use down arrow to highlight "Reset" then press enter. This will access "Reset" menu. Press the "YES" and then press accept. The controller will reset and begin start up sequence.

Note: Alternately, the control can be reset by opening and closing the circuit breaker switch and waiting 70 seconds to resume normal operation.



Always use proper precautions when accessing circuit breaker box.

Troubleshooting



Problem:

If screen displays "----" instead of a measured value

Solution:

1. Sensor is not connected or functioning properly.
2. Check the connection at the sensor and the connection within the control module.

⚠ DANGER

BEFORE attempting to open Control Module, a certified and qualified electrician MUST fully de-energize and disconnect all electrical power from DigiTemp.

Perform required LOCK OUT/TAG OUT procedures.

When done, reconnection and reenergizing of DigiTemp MUST be performed by certified and qualified electrician.

3. Disconnect all power and fully de-energize DigiTemp BEFORE opening the control module. Open the Control Module and locate the sensor.
4. Unlock the control and power up the system and then select the "Toolbox" to navigate to the "Toolbox" menu. From within the "Toolbox" menu use down arrow to highlight "Reset" then press enter. This will access "Reset" menu. Press the "YES" and then press accept. The controller will reset and begin start up sequence.

Note: Alternately, the control can be reset the control by opening and closing the circuit breaker switch and waiting 70 seconds to resume normal operation.



Always use proper precautions when accessing circuit breaker box.

5. Waiting 1-5 minutes for the control to resume normal operation Also, ensure that there is a load (at least one tap on the mixed outlet system) present while the control is resuming normal operation.

Error Codes

If the control detects a problem, an error will display on the Home screen and from within the “Toolbox” menu. To navigate to the “Toolbox” menu unlock the control and select “Toolbox”. Resolution is in the chart below.

Code	Description	Resolution	Control Behavior during Error Condition
1	NVM Error	Verify settings in applicable menu and / or load defaults.	Valve closes and operation ceases.
2	Mixed Outlet Sensor Error	Check the sensor wiring. Sensor may need to be replaced.	Valve closes and operation ceases.
3	High Temperature Alert	Check valve position. Considering increasing corresponding differential setting.	Operation continues.
4	Low Temperature Alert	Check valve position. Considering increasing corresponding differential setting.	Operation continues.

Replacement Part Numbers

Replacement Part#	Description
160773	Kit, PVI Mixing Valve and Actuator Kit DigiTemp ¾" 3-Way Model V23
160776	Kit, PVI Mixing Valve and Actuator Kit DigiTemp 1" 3-Way Model V55
160779	Kit, PVI Mixing Valve and Actuator Kit DigiTemp 1 ½" 3-Way Model V71
160782	Kit, PVI Mixing Valve and Actuator Kit DigiTemp 2" 3-Way Model V125
160785	Kit, PVI Actuator DigiTemp
160788	Kit, PVI Temperature Sensor DigiTemp High Speed with Wire
160791	Kit, PVI DigiTemp Controller

Scheduled Testing, Inspection and Maintenance

Testing/Inspection

WARNING

Need for Periodic Inspection/Maintenance: This product must be tested periodically in compliance with local codes, but at least once per year or more as service conditions warrant. All products must be retested once maintenance has been performed. Corrosive water conditions and/or unauthorized adjustments or repair could render the product ineffective for the service intended. Regular checking and cleaning of the product's internal and external components helps assure maximum life and proper product function.

Maintenance

■ Actuator and/or Valve Removal

NOTICE

Valves and actuators are not field serviceable. They must be removed and replaced.

Tools Required:

- 10mm and 3/8" sockets, elbow and torque wrench. Not required if replacing both valve and actuator
- T30 Torx driver. Not required if replacing both valve and actuator
- 2.5mm Allen key. Not required if replacing both valve and actuator
- 1/8" (3.2mm, #2) slot screwdriver. Not required for valve only replacement
- Wire Stripper and snips. Not required for valve only replacement
- AC Voltmeter. Not required for valve only replacement
- Five to ten 4" zap straps (cable ties)
- 4" monkey wrenches (gas grips)
- 3" adjustable wrenches (shifting spanner)
- Teflon Tape. Not required for actuator only replacement

■ Actuator Removal Instructions

DANGER



BEFORE attempting to open Control Module, a certified and qualified electrician MUST fully de-energize and disconnect all electrical power from DigiTemp.

Perform required LOCK OUT/TAG OUT procedures.



When done, reconnection and reenergizing of DigiTemp MUST be performed by certified and qualified electrician.

Scheduled Testing, Inspection and Maintenance

1. Disconnect all power and fully de-energize the DigiTemp system.
2. Once de-energized and disconnected, the display will become inactive and the control box can be opened.
3. Pop open the controller cover and then loosen two screws to expose actuator connection.



As an additional safety check, once the box is open, confirm that the unit is de-energized by measuring the AC voltage across the “L” and “N” terminals (46 and 45 respectively) using the voltmeter. Alternatively, use a voltage detector to confirm that the unit is NOT energized.

NOTICE

Skip step 3 and 4 if only removing actuator for valve replacement.

4. Using the slot screwdriver loosen terminals 1 to 3 in the upper left side of the control module. Take note of the wire colors connected to each of the terminals.

This connection should be as follows:

- 1) Grey 2) Black 3) Red

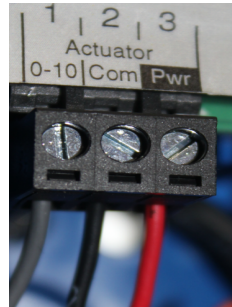

5. Remove the Actuator Cables from the control box.
6. Remove the actuator from the valve as follows:
 - a. Using the T30 Torx driver remove the two actuator support plate T30 Torx screws
 - b. Using the 10mm wrench loosen the actuator armature clamping nut
 - c. Using the T30 Torx driver completely remove the support plate T30 Torx screws
 - d. At this point the actuator should be free to slide off the valve stem away from the valve. If not, further loosen the actuator armature clamping nut
 - e. Carefully remove the actuator and set it aside.

Actuator

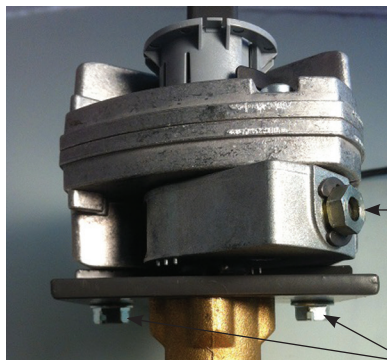

Armature Clamping Nut

Support Plate
T30 Torx screws

Scheduled Testing, Inspection and Maintenance

Valve Replacement

1. Follow actuator replacement above.
2. Remove bracket and controller from the valve
3. Un-plug sensor from the valve.
4. Remove valve and replace. Install bracket, controller and plug sensor
5. Install actuator. Using the T30 Torx driver, install the support plate T30 Torx screws (see below) until snug. Ensure that the support plate bolts are sufficiently loose to allow for some very slight movement between the support plate and the actuator. This play will allow the actuator to find the proper position when the armature clamping nut is tightened down.

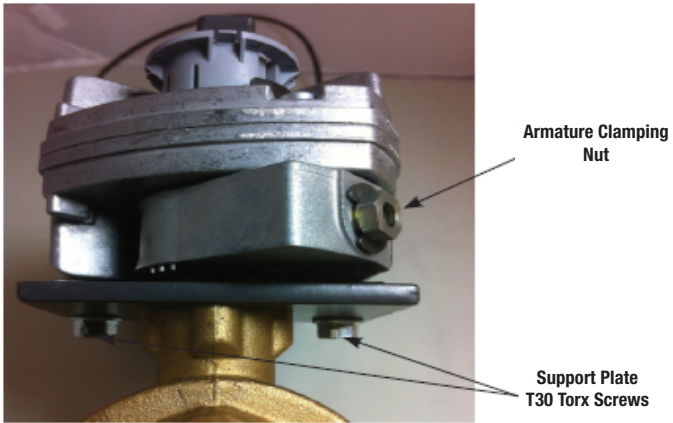

6. The actuator armature must be positioned in the un-powered rest position. Make sure "T" marking on the valve stem is pointing towards mixed outlet. See picture below.

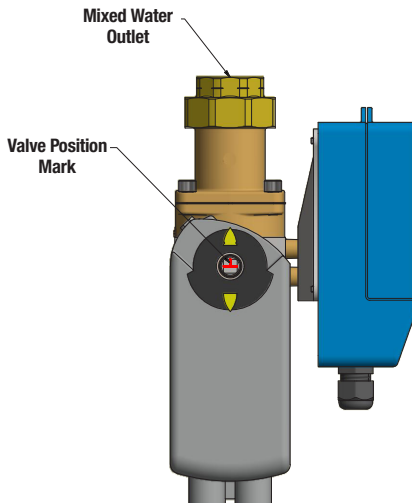

Scheduled Testing, Inspection and Maintenance

7. Tighten down the armature clamping nut using the 10mm socket and torque wrench to 50 in-lb (5.65 N-m)
8. Using the 3/8" socket, elbow and torque wrench, torque down the support plate nut to 50 in-lb.

NOTICE

Take caution not to over tighten and strip these nuts.

9. Run the control wires up to the control along the same path as when removed.
10. Wire to terminal blocks as follows:
 1. Grey
 2. Black
 3. Red

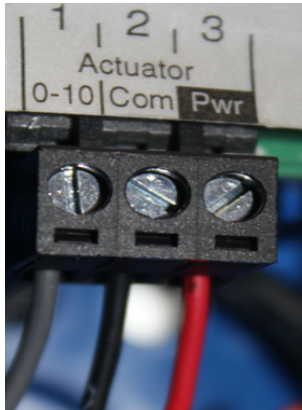

NOTICE

Pink and orange actuator wires are not used by this control

8. Utilize cable ties to secure the wires and close the control module. Once the box is closed, re-energize the unit.
9. Resume normal operation and observe that the actuator and valve are now working properly.



A WATTS Brand

Hot Water Solutions

Fort Worth, TX • (817) 335-9531 • PVI.com

© 2022 PVI