

Cobrex[®] Semi-Instantaneous

Steam-Fired Domestic Hot Water Generator



AquaPLEX[®]
Engineered Duplex Alloy

Up to 7000 MBH | 150/ 175/ 215 Gallon Tank | 25-year Warranty

PVI.com



Steam-Fired Domestic Hot Water Generator

Cobrex® Semi-Instantaneous steam water heaters utilize a double-wall, copper-tube, counter-flow heat exchanger to provide moderate to large amounts of domestic hot water using steam as its energy source. The heat exchanger is external to the small tank for the smallest footprint, accessible through a 3 foot door and a great solution for retrofit applications. Heat exchanger and tank are connected with factory-assembled piping. With Cobrex paired to AquaPLEX® tanks of 150 through 215 gallons, this semi-instantaneous offering will handle peak loads as well as dump loads. Cobrex semi-instantaneous features electronic operating control with Modbus connectability to a building automation system. With the Cobrex unique operation, no steam control valve is necessary when inlet steam pressure is 15 psi or less.

Features and Benefits

- Up to 7000 MBH output
- Up to 8425 gph hot water delivery from 40 to 140°F
- Duplex stainless steel tank with 150, 175, 215 gallons storage
- 100% copper and brass, double-wall, shell-and-tube heat exchanger with single-pass, counterflow design
- Redundant dual heat exchangers available
- No steam control valve required at ≥ 15 psi steam
- Twenty-five year pressure vessel corrosion warranty



Shown with optional steam header

Advantages of the Cobrex® Water Heater

No Steam Control Valve Needed with ≤15 psi Steam

Provides simplified heater operation and lower maintenance cost. Design eliminates a typically large and expensive steam control valve and actuator and the associated maintenance and replacement cost.

Circulation Flow Diffusers

Diffusers dissipate the pressure and velocity of the water circulating back into the vessel from the heat exchanger. This allows 80% of the water stored in the tank to exit the heater at usable temperature.

Redundancy

Dual heat exchanger models can be operated and isolated independently to allow maintenance on one exchanger without an interruption in hot water supply.

Circulation Pump and Condensate Control System

Scaling in the heat exchanger is minimized by constant water circulation during a call for heat and a pump delay after the call for heat terminates. The condensate shutoff valve quickly causes the exchanger to completely fill with condensate and stops the flow of steam. Stopping steam flow and continuing domestic water flow combine to cool the exchanger below the temperature threshold where scale can precipitate from the water.

Heat Exchanger

- **Heat Exchanger and Tank on Separate Skids**

Installation of the entire system is greatly simplified by reducing the size and weight of the individual parts. The piping between the tank and heat exchanger is fully fabricated at the factory for simple field installation.

- **Not Immersed in the Tank**

Heat exchanger removal is greatly simplified and the required pull space is only one heat exchanger diameter (maximum 10") away from the mounting stand.

- **Lighter Weight and Easier to Move**

The largest heat exchanger is only 100 lbs. and is a fraction of the weight of a typical double-wall u-tube exchanger of equal capacity and greatly simplifies replacement if necessary.

- **Clean-in-place Fittings**

The heat exchanger can be de-scaled in place without disconnecting any plumbing.

Safety and Operating Controls

- **Redundant Temperature and Safety Controls**

The combination of an electronic controller, high limit, pump shutoff, condensate shutoff valve and heat trap piping at the heat exchanger outlet prevent an over-temperature condition in the vessel.

- **BAS Connectible Operating Control**

Full read/write capability through electronic operating control with Modbus protocol. BACnet gateways are available. Functions such as temperature setback, and remote over-temperature alarm notification are available.

AquaPLEX® Storage Tank

Standard 25-year corrosion warranty. The duplex stainless steel tank is fully pickle-passivated and is naturally immune to corrosion in all potable waters. The tank requires no linings and no anodes rods or induced current anodes for corrosion protection. Unlike 316L or 304L stainless tanks, there is no concern about chloride stress corrosion cracking.

Heater Components

Heat Transfer and Condensate Control System

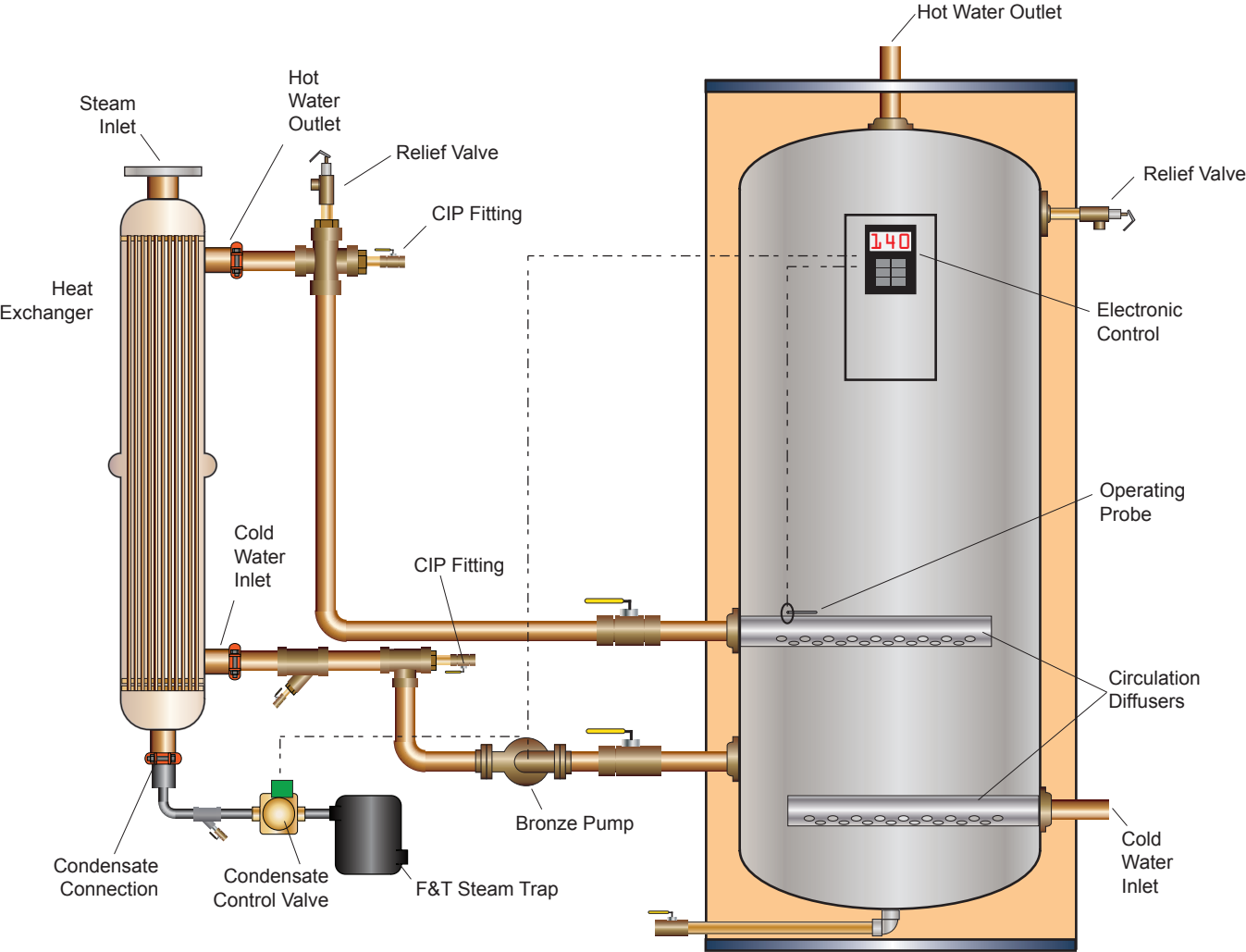

How It Works

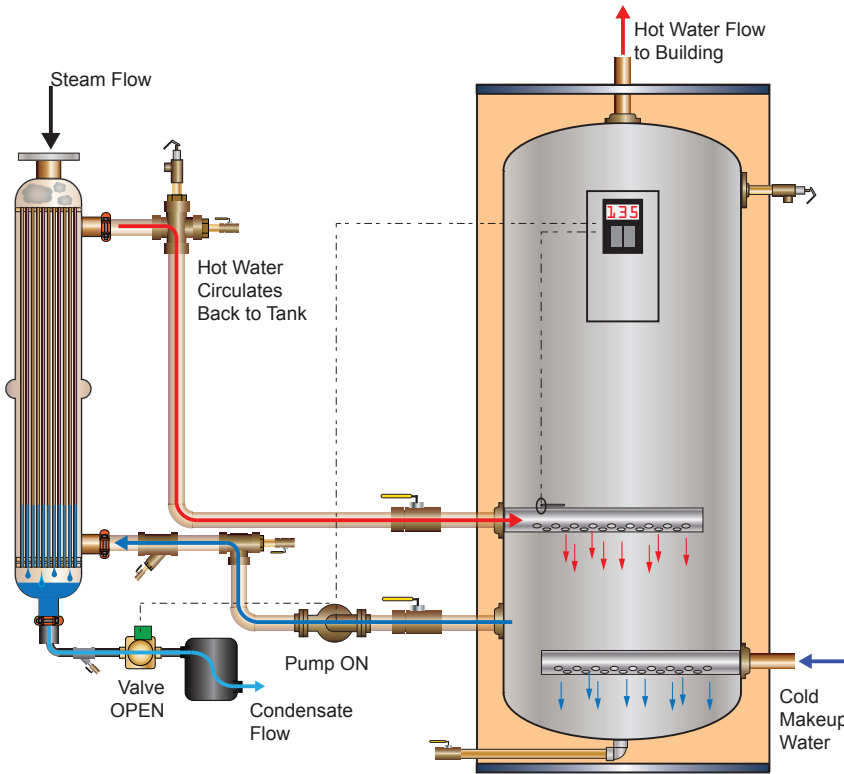

Call for Heat Begins

Demand for hot water causes cold makeup water to enter the storage tank and reduces tank temperature. The operating probe senses the temperature drop signaling the control to energize the pump between tank and heat exchanger and opens the condensate valve. The pump draws cold domestic water through the exchanger, extracting heat from the steam causing it to condense and evacuate through the steam trap. The pressure drop caused by condensing steam causes more steam to enter the exchanger and the process continues. The heated water flows back to the storage tank through diffuser tubes that prevent the circulated flow from disturbing the natural stratification of water in the tank and allows more than 80% of usable hot water from storage to enter the building at the required temperature. When demand for hot water ends, the pump will continue to operate until the tank returns to the required stored water temperature thus ending the process.

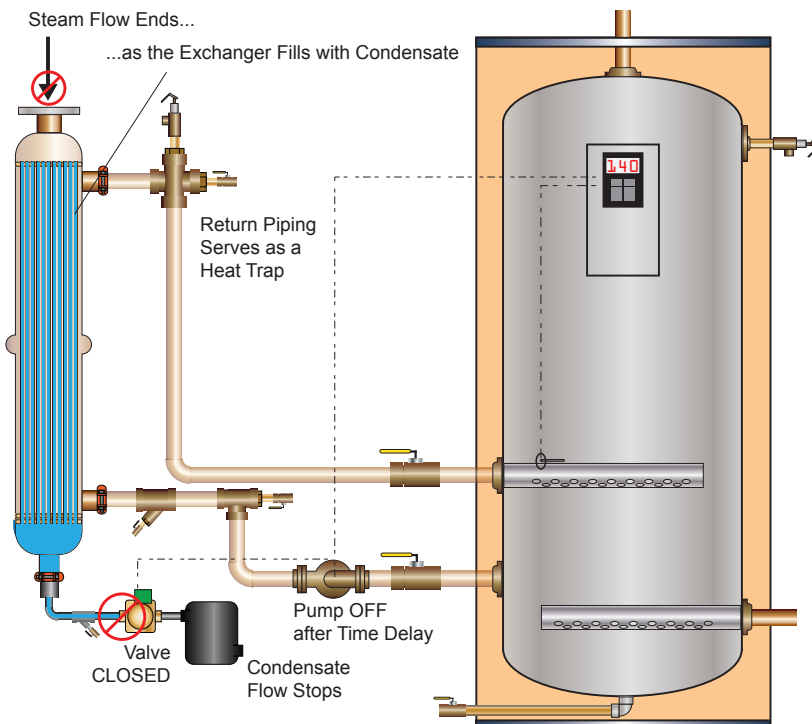

Call for Heat Ends

(Condensate Control System)

Immediately after the call for heat terminates, the condensate valve is closed, trapping condensate in the heat exchanger. Steam continues to condense until the exchanger is filled with condensate and the flow of steam is stopped completely. The pump remains energized for an additional minute to extract any residual heat from the exchanger and transfers it into the domestic water in the tank. The pump delay raises steam tank temperature an additional 2°F.

Robust Heat Exchanger

The Cobrex heat exchanger is a shell-and-tube design with domestic water in the shell and steam/condensate in the tubes. The exchanger is vertically oriented and single-pass. Steam and water paths are 100% counterflow and provide the greatest possible temperature differential at all points in the heat exchanger. The domestic water side also contains several baffles to create a circuitous and high velocity flow. This allows large amounts of hot water to be generated from a remarkably small heat exchanger. The straight, copper, double-wall tubes are brazed into brass tube sheets and contained within a solid copper shell. The exchanger is ASME stamped to Section VIII for 150psi maximum allowable working pressure (MAWP).

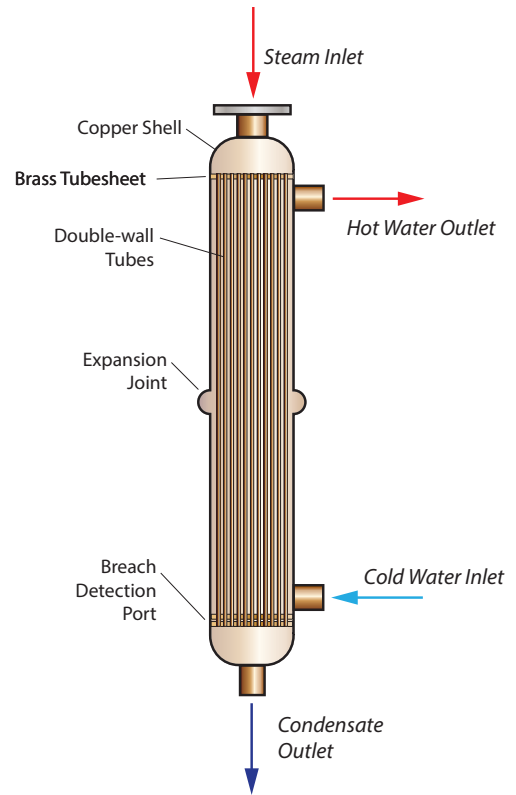

Specifications

Available Configurations and Performance

Model	Btuh Output (@ 15 psi steam)	Btuh per Gallon	Recovery 40° to 140°F		Configuration
			gallon/min	gallon/hour	
1200	840,000	5600	17	1010	single exchanger
1800	1,530,000	10,200	31	1840	single exchanger
2700	3,000,000	20,000	60	3600	single exchanger
3600	3,500,000	23,330	70	4215	single exchanger
1200-2	1,680,000	11,200	34	2020	dual exchanger
1800-2	3,070,000	20,467	61	3680	dual exchanger
2700-2	6,000,000	40,000	120	7200	dual exchanger
3600-2	7,000,000	46,667	140	8425	dual exchanger

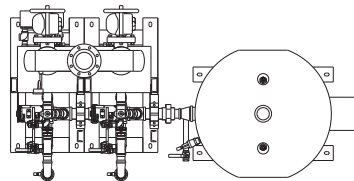
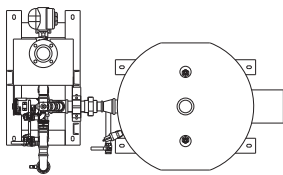

Electrical Requirements
115/120VAC 60 Hz. 10 amps

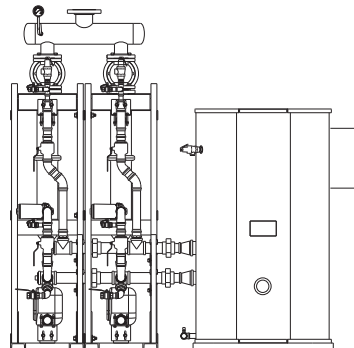
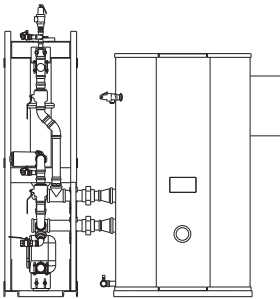

Single Exchanger Configuration

Dual Exchanger Configuration
(Steam header and steam isolation valves are field-installed options)

Standard Equipment

- Heat exchanger ASME stamped, section VIII for 150 psi
- Pressure vessel ASME stamped, section IV HLW for 150 psi
- Three year heat exchanger warranty
- 25-year pressure vessel warranty
- Completely pre-fabricated tank-to-exchanger piping is all non-ferrous and includes pump, y-strainer, isolation valves, unions, CIP valves and ASME relief valve
- Factory-authorized startup and first year service policy
- Bottom drain valve and ASME relief valve
- Float and thermostatic steam trap
- Electronic operating control with MODBUS capability
- High-temperature limit
- Manway tank access (250 to 900 gallons)
- Complies with latest ASHRAE 90.1 standard
- Low lead compliant

Refer to document PV8570 for complete list of standard and optional equipment



Hot Water Solutions

PVI Industries | Fort Worth, TX
T: (817) 335-9531 | Toll Free: (800) 784-8326 | PVI.com