

# Installation, Operation and Maintenance Manual

## Smart Boiler Expansion 294EXP

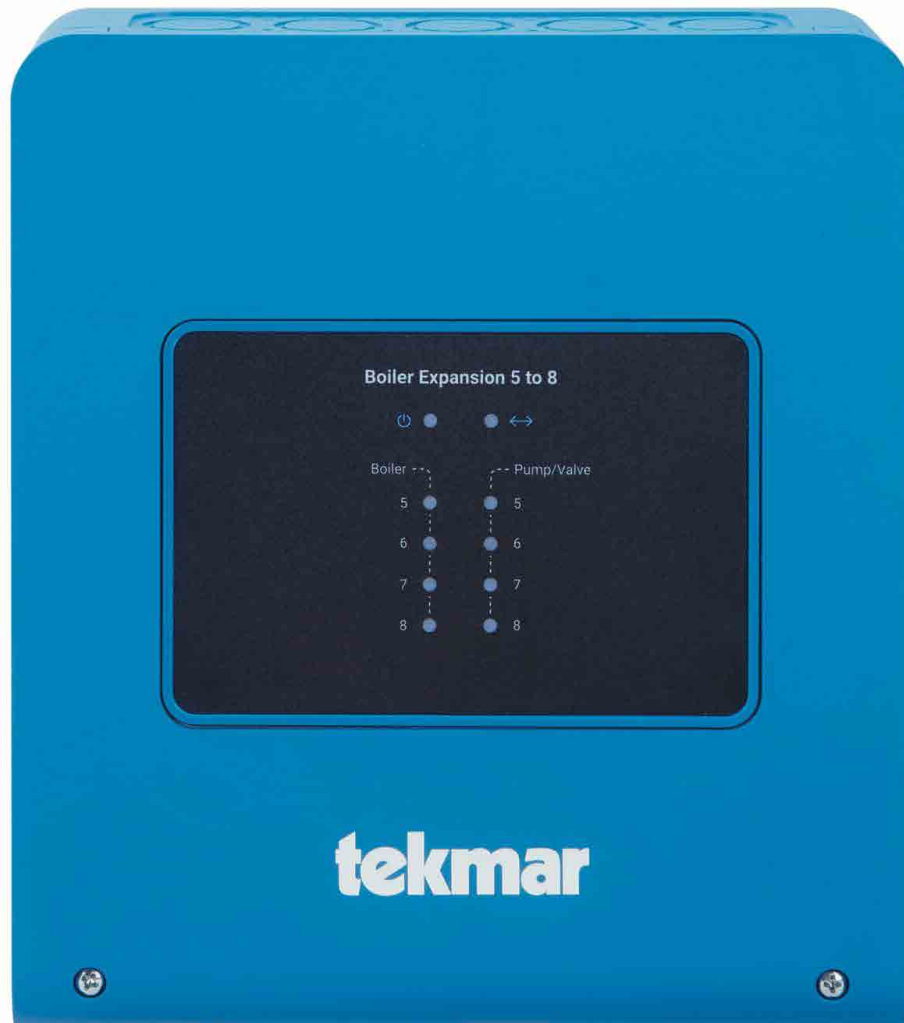

### ⚠ WARNING



Please read carefully before proceeding with installation. Your failure to follow any attached instructions or operating parameters may lead to the product's failure.

Keep this Manual for future reference.

**THINK  
SAFETY  
FIRST**

**tekmar**<sup>®</sup>  
A WATTS Brand

# Table of Contents

Important Safety Information . . . . .	3
Radio Frequency Statement . . . . .	4
Installation . . . . .	5
Installation Location . . . . .	5
Wiring Schematic . . . . .	6
Wiring Instructions . . . . .	7
User Interface . . . . .	9
Status Icons . . . . .	9
Labels for Boilers 9 to 12 or 13 to 16 . . . . .	9
Sequence of Operation . . . . .	10
DIP Switches . . . . .	10
Power On LED . . . . .	10
Communication LED . . . . .	10
Boiler Output Operation . . . . .	10
Troubleshooting. . . . .	11
Technical Data. . . . .	12
Limited Warranty & Product Return Procedure. . . . .	12

# Important Safety Information

## ⚠ WARNING

It is your responsibility to ensure that this control is safely installed according to all applicable codes and standards. tekmar® is not responsible for damages resulting from improper installation and/or maintenance.

To avoid serious personal injury and damage to the equipment:



- Read Manual and all product labels BEFORE using the equipment. Do not use unless you know the safe and proper operation of this equipment.



- Keep this Manual available for easy access by all users.
- Replacement Manuals are available at [tekmarControls.com](http://tekmarControls.com)



This is a safety-alert symbol. The safety alert symbol is shown alone or used with a signal word (DANGER, WARNING, or CAUTION), a pictorial and/or a safety message to identify hazards.

When you see this symbol alone or with a signal word on your equipment or in this Manual, be alert to the potential for death or serious personal injury.



This pictorial alerts you to electricity, electrocution, and shock hazards.



Double insulated.

## ⚠ WARNING

This symbol identifies hazards which, if not avoided, could result in death or serious injury.

## ⚠ CAUTION

This symbol identifies hazards which, if not avoided, could result in minor or moderate injury.

## NOTICE

This symbol identifies practices, actions, or failure to act which could result in property damage or damage to the equipment.

## ⚠ WARNING

- It is the installer's responsibility to ensure that this control is safely installed according to all applicable codes and standards.
- Improper installation and operation of this control could result in damage to the equipment and possibly even personal injury or death.
- This control is not intended for use as a primary limit control. Other controls that are intended and certified as safety limits must be placed into the control circuit.

## NOTICE

Do not attempt to service the control. There are no user serviceable parts inside the control. Attempting to do so voids warranty.

# Radio Frequency Statement

This equipment has been tested and found to comply with the limits for a Class A digital device, pursuant to part 15 of the FCC Rules. These limits are designed to provide reasonable protection against harmful interference when the equipment is operated in a commercial environment. This equipment generates, uses, and can radiate radio frequency energy and, if not installed and used in accordance with the instruction manual, may cause harmful interference to radio communications. Operation of this equipment in a residential area is likely to cause harmful interference in which case the user will be required to correct the interference at his own expense.

This device complies with part 15 of the FCC Rules and with Industry Canada license-exempt RSS standard(s). Operation is subject to the following two conditions: (1) this device may not cause harmful interference, and (2) this device must accept any interference received, including interference that may cause undesired operation.

The antenna used for this radio must be properly installed and maintained and must provide a separation distance of at least 7.9 inches (20 cm) from all persons.

Changes or modifications not expressly approved by the party responsible for compliance could void the user's authority to operate the equipment.

*Le présent appareil est conforme aux CNR d'Industrie Canada applicables aux appareils radio exempts de licence. L'exploitation est autorisée aux deux conditions suivantes:*

*(1) l'appareil ne doit pas produire de brouillage, et*

*(2) l'utilisateur de l'appareil doit accepter tout brouillage radioélectrique subi, même si le brouillage est susceptible d'en compromettre le fonctionnement.*

# Installation

## Installation Location

When choosing the location for the control, consider the following:

- Keep dry. Avoid potential leakage onto the control.  
RH ≤ 90% to 104°F (40°C).  
Non-condensing environment.
- Do not expose to operating temperatures beyond 32-104°F (0-40°C)
- Provide adequate ventilation.
- Keep away from equipment, appliances or other sources of electrical interference.
- Provide easy access for wiring, viewing, & adjusting the display screen.
- Mount approximately 5 ft. (1.5 m) off the finished floor.
- Locate the control near pumps &/or zone valves if possible.
- Provide a solid backing to mount the enclosure to. For example: plywood, studs, etc
- Use the conduit knockouts provided on the upper, lower, back & sides of the enclosure.

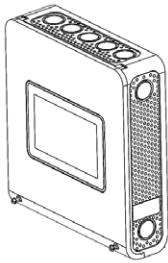

Use a Phillips screwdriver to remove the two screws on the cover.

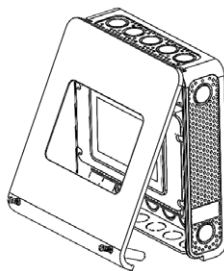

Pull the front cover towards you. The top of the cover will pivot on a hinge. Remove the cover by releasing the pivot hooks.

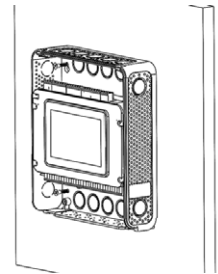

Mount the enclosure to a wall using #6 wood screws in the four mounting holes. Use screw anchors if drilling into masonry.

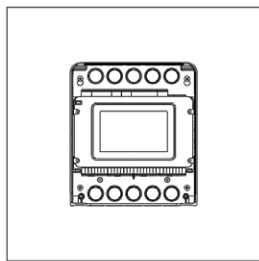

Use the 24 knock-outs to install connecting conduits and cabling to the control.

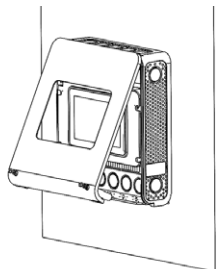

To install the cover, hook the top of the cover to the enclosure, then pivot the bottom to shut.

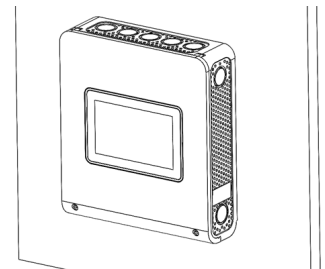

Use a Phillips screwdriver to fasten the two bottom screws.

# Wiring Schematic

This section provides a wiring schematic for the control.

## ⚠ WARNING

- Before wiring, ensure all power is turned off and take all necessary precautions.
- Strip all wiring to a length of 3/8 in. or 10 mm for all terminals.
- A circuit breaker or power disconnect that provides power to the control should be located nearby & clearly labeled.
- Refer to the current and voltage ratings at the back of this brochure before connecting devices to this control.
- Only qualified personnel should install or service the control.

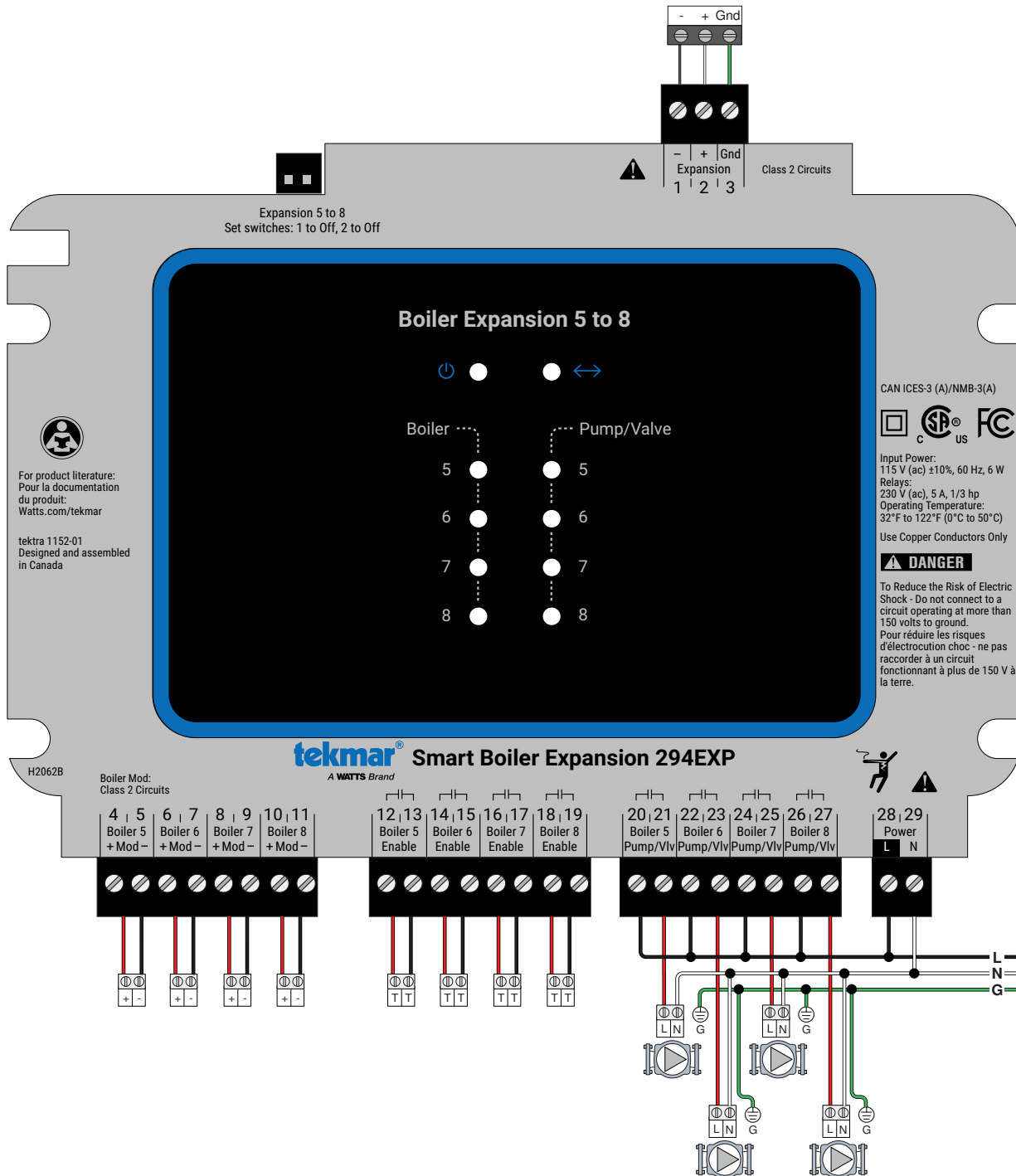

# Wiring Instructions

This section explains how to wire individual devices to the Smart Boiler Expansion 294EXP.

## Boiler Expansion (Terminals 1, 2, 3)

The control operates 4 on board boilers and is expandable in groups of 4 up to a maximum of 16 through the use of boiler expansions. The control connects to the expansion through a wired three-wire connection. The maximum bus cable length is 100 feet (30 m) using 18 AWG solid conductor cable.

- Connect the 294 terminal 18 (-) to the 294EXP terminal 1 (-).
- Connect the 294 terminal 19 (+) to the 294EXP terminal 2 (+).
- Connect the 294 terminal 20 (Gnd) to the 294EXP terminal 3 (Gnd).

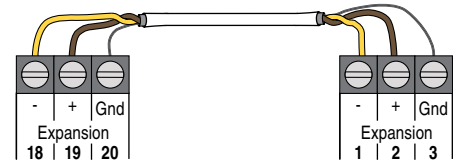

## Modulating Boilers (Terminals 4 to 11)

The control provides either a 0-10 V (dc) or a 4-20 mA output to each boiler. Polarity is important.

- Connect the control Mod (+) terminals 4, 6, 8, 10 to boilers 5, 6, 7 and 8 analog signal input (+) respectively.
- Connect the control Mod (-) terminals 5, 7, 9, 11 to boilers 5, 6, 7 and 8 analog signal input (-) respectively.

**Some modulating boilers may also require a boiler on/off enable signal in addition to the modulating signal. Please consult the boiler manual.**

The 4 to 20 mA output can be converted to a 0 - 135  $\Omega$  output for a Modutrol IV™ gas valve actuating motor using a 0 - 135  $\Omega$  tekmar Converter 005 (sold separately).

The 4 to 20 mA output can be converted to a 0 - 135  $\Omega$  output for a V9055™ gas valve actuating motor using a 0 - 135  $\Omega$  tekmar Converter 005 (sold separately).

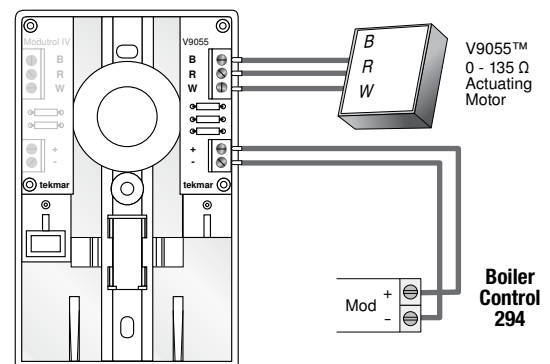
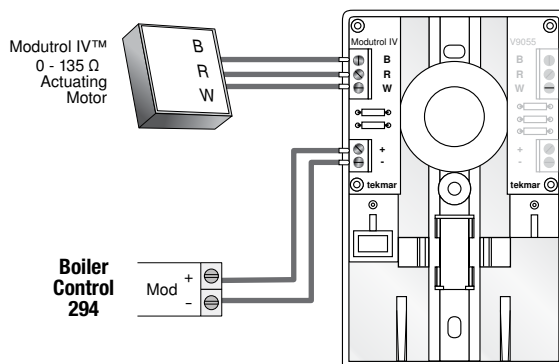

Modutrol IV™ and V9055™ are trademarks of Honeywell, Inc.

## Boiler Enable (Terminals 12 to 19)

A single stage condensing or non-condensing boiler is enabled through the TT contacts.

- For Boiler 5 connect the Boiler Enable terminals 12 and 13 to the boiler TT contacts.
- For Boiler 6 connect the Boiler Enable terminals 14 and 15 to the boiler TT contacts.
- For Boiler 7 connect the Boiler Enable terminals 16 and 17 to the boiler TT contacts.
- For Boiler 8 connect the Boiler Enable terminals 18 and 19 to the boiler TT contacts.

## Boiler Pump / Valve (Terminals 20 to 27)

Boiler pumps or valves requiring up to 230 V (ac) 5 A, 1/3 hp can be switched through terminals 20 to 27. If a single power source is used for multiple pumps, ensure they are not tied together at any point between the pumps and the control. For simplicity in wiring and troubleshooting, a separate breaker for each pump is recommended.

For pumps:

- Connect the power source line wire (L) to terminal 20.
- Connect a wire from terminal 21 to the pump Line In terminal.
- Connect the pump Neutral (N) to the power source neutral.
- Repeat for additional boiler pumps 6 (terminals 22, 23), boiler pump 7 (24, 25) and boiler pump 8 (terminals 26, 27).
- Ensure each pump is connected to earth ground.

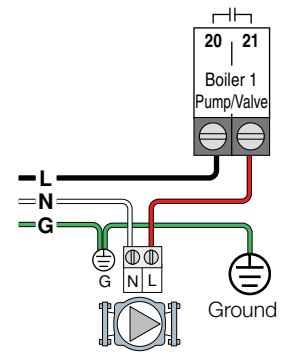

For 120 V (ac) valves:

- Connect the power source line wire (L) to terminal 20.
- Connect a wire from terminal 21 to the valve Line In terminal.
- Connect the valve Neutral (N) to the power source neutral.
- Repeat for additional valves 6 (terminals 22, 23), valve 7 (24, 25) and valve 8 (terminals 26, 27).
- Ensure each pump is connected to earth ground.

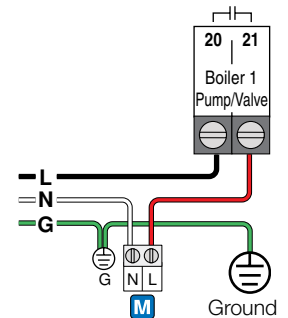

For 24 V (ac) valves:

- Connect the power source Red wire (R) to terminal 20.
- Connect a wire from terminal 21 to the valve power terminal.
- Connect the valve power common to the power source common (C).
- Repeat for additional boiler valves 6 (terminals 22, 23), boiler valve 7 (24, 25) and boiler valve 8 (terminals 26, 27).

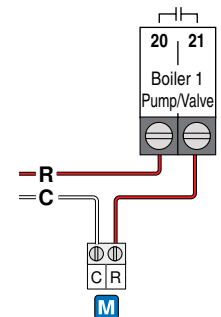

## Input Power (Terminals 28, 29)

Provide a 15 Amp circuit for the input power.

- Connect the 115 V (ac) line wire (L) to terminal 28.
- Connect the neutral wire (N) to terminal 29.





# User Interface

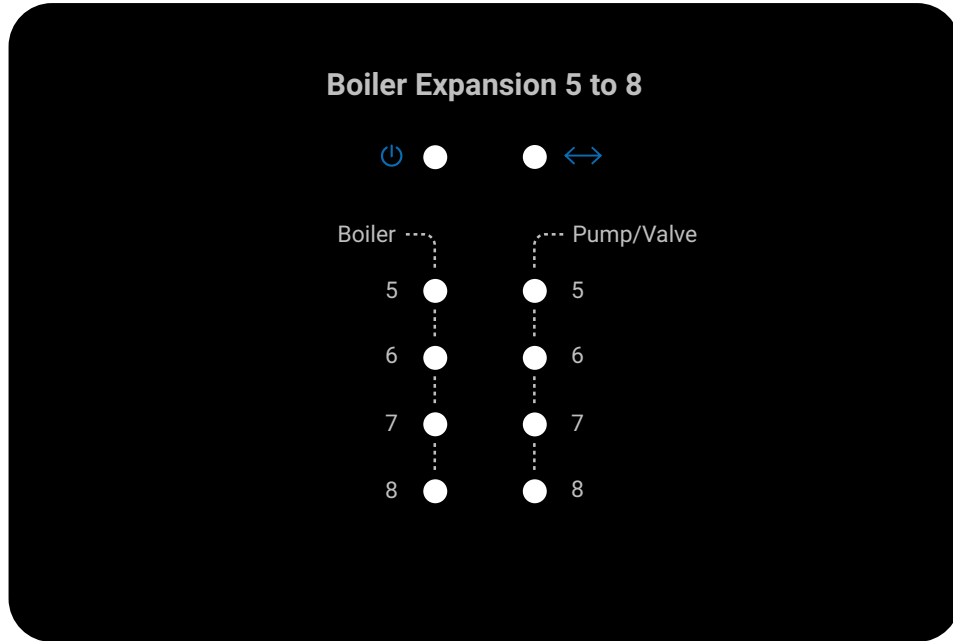

## Status Icons

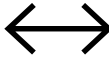
	<p><b>POWER</b> LED is on when powered.</p>		<p><b>COMMUNICATION</b> LED is on when communicating to 294.</p>
---	---	--	--

## Labels for Boilers 9 to 12 or 13 to 16

The 294EXP is assembled from the factory with labels to operate boilers 5 through 8. Included in the packaging are labels for boilers 9 to 12 and another set for boilers 13 to 16. If operating one of these boiler groups, locate the correct label, peel the label from the backing, and using the plastic oval shape as a guide, apply the label to on top of the existing label.

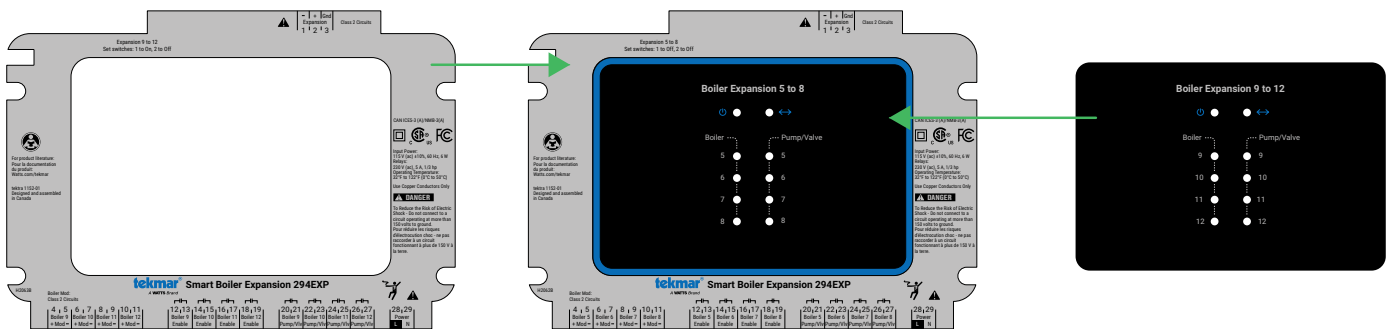

# Sequence of Operation

## DIP Switches

Two DIP switches located on the top left side of the control. The DIP switch positions determine the boiler groups that the Smart Boiler Expansion 294EXP operates.

<b>Boilers</b>	<b>DIP Switch 1</b>	<b>DIP Switch 2</b>
5 to 8	Off	Off
9 to 12	On	Off
13 to 16	Off	On

## Power On LED

The power LED operates as follows.

<b>LED</b>	<b>Operation</b>
On	Power applied and control is operating correctly
Off	No power or the control is faulty

## Communication LED

When powered on, the Smart Boiler Expansion 294EXP communicates to the Smart Boiler Control 294. The communication LED operates as follows.

<b>LED</b>	<b>Operation</b>
On	Communication with 294
Off	No communication with 294

## Boiler Output Operation

All boiler relays are normally off and the modulating outputs at 0 V (dc) or 4 mA. The Smart Boiler Control 294EXP responds to commands from the 294 to turn on a boiler, the modulating signal, and the boiler pump or valve. The status on the 294EXP display will match the 294 Boiler Status menu.

<b>Output</b>	<b>LED</b>	<b>Operation</b>
Boiler 5, 9, 13	On	Boiler enable 5, 9, 13 relay is closed
	Off	Boiler enable 5, 9, 13 relay is open
Boiler 6, 10, 14	On	Boiler enable 6, 10, 14 relay is closed
	Off	Boiler enable 6, 10, 14 relay is open
Boiler 7, 11, 15	On	Boiler enable 7, 11, 15 relay is closed
	Off	Boiler enable 7, 11, 15 relay is open
Boiler 8, 12, 16	On	Boiler enable 8, 12, 16 relay is closed
	Off	Boiler enable 8, 12, 16 relay is open
Boiler Pump/Valve 5, 9, 13	On	Boiler pump/valve 5, 9, 13 relay is closed
	Off	Boiler pump/valve 5, 9, 13 relay is open
Boiler Pump/Valve 6, 10, 14	On	Boiler pump/valve 6, 10, 14 relay is closed
	Off	Boiler pump/valve 6, 10, 14 relay is open
Boiler Pump/Valve 7, 11, 15	On	Boiler pump/valve 7, 11, 15 relay is closed
	Off	Boiler pump/valve 7, 11, 15 relay is open
Boiler Pump/Valve 8, 12, 16	On	Boiler pump/valve 8, 12, 16 relay is closed
	Off	Boiler pump/valve 8, 12, 16 relay is open

# Troubleshooting

Symptom	Description
Power LED Off	Using an electrical meter, check that the supply voltage is between 103.5 and 126.5 V (ac). If the supply voltage is correct and the Power LED remains off the control may be faulty.
Communication LED Off	Check that the boiler expansion on wiring terminals 1, 2, and 3 are connected using 3-conductor 18 AWG LVT wire if connections are less than 100 feet (30 m). Connections exceeding 100 feet (30 m) or installed in high radio-frequency environments should use 3-conductor, 22 AWG shielded-twisted pair. The boiler expansion wiring is polarity sensitive so it is important to check that the wire color codes are in the correct terminal locations.

## Technical Data

Smart Boiler Control 294	
Literature	Submittal, Installation and Operating Manual
Packaged weight	2.4 lb. (1100 g)
Dimensions	9" H x 8" W x 2 <sup>11</sup> / <sub>16</sub> " D (229 x 203 x 60 mm)
Enclosure	Blue ABS plastic, NEMA type 1
Approvals	CSA C US, FCC Part 15B, ICES-003 Class A
Ambient conditions	Indoor use only, 32 to 122°F (0 to 50°C), < 90% RH non-condensing, Altitude < 6560 feet (2000 m), Installation Category II, Pollution Degree 2
Power supply	115 V (ac) ±10%, 60 Hz, 6 W
Relays	230 V (ac), 5 A, 1/3 hp
Modulating outputs	0-10 V (dc) 500 Ω minimum load impedance or 4-20 mA 1 kΩ max load impedance

## Limited Warranty and Product Return Procedure

**Limited Warranty** *The liability of tekmar under this warranty is limited. The Purchaser, by taking receipt of any tekmar product ("Product"), acknowledges the terms of the Limited Warranty in effect at the time of such Product sale & acknowledges that it has read & understands same.*

**The tekmar Limited Warranty to the Purchaser on the Products sold hereunder is a manufacturer's pass-through warranty which the Purchaser is authorized to pass through to its customers. Under the Limited Warranty, each tekmar Product is warranted against defects in workmanship & materials if the Product is installed & used in compliance with tekmar's instructions, ordinary wear & tear excepted. The pass-through warranty period is for a period of twenty-four (24) months from the production date if the Product is not installed during that period, or twelve (12) months from the documented date of installation if installed within twenty-four (24) months from the production date.**

The liability of tekmar under the Limited Warranty shall be limited to, at tekmar's sole discretion: the cost of parts & labor provided by tekmar to repair defects in materials &/or workmanship of the defective product; or to the exchange of the defective product for a warranty replacement product; or to the granting of credit limited to the original cost of the defective product, & such repair, exchange or credit shall be the sole remedy available from tekmar, &, without limiting the foregoing in any way, tekmar is not responsible, in contract, tort or strict product liability, for any other losses, costs, expenses, inconveniences, or damages, whether direct, indirect, special, secondary, incidental or consequential, arising from ownership or use of the product, or from defects in workmanship or materials, including any liability for fundamental breach of contract.

The pass-through Limited Warranty applies only to those defective Products returned to tekmar during the warranty period. This Limited Warranty does not cover the cost of the parts or labor to remove or transport the defective Product, or to reinstall the repaired or replacement Product, all such costs & expenses being subject to Purchaser's agreement & warranty with its customers.

Any representations or warranties about the Products made by Purchaser to its customers which are different from or in excess of the tekmar Limited Warranty are the Purchaser's sole responsibility & obligation. Purchaser shall indemnify & hold tekmar harmless from & against any & all claims, liabilities & damages of any kind or nature which arise out of or are related to any such representations or warranties by Purchaser to its customers.

The pass-through Limited Warranty does not apply if the returned Product has been damaged by negligence by persons other than tekmar, accident, fire, Act of God, abuse or misuse; or has been damaged by modifications, alterations or attachments made subsequent to purchase which have not been authorized by tekmar; or if the Product was not installed in compliance with tekmar's instructions &/or the local codes & ordinances; or if due to defective installation of the Product; or if the Product was not used in compliance with tekmar's instructions.

THIS WARRANTY IS IN LIEU OF ALL OTHER WARRANTIES, EXPRESS OR IMPLIED, WHICH THE GOVERNING LAW ALLOWS PARTIES TO CONTRACTUALLY EXCLUDE, INCLUDING, WITHOUT LIMITATION, IMPLIED WARRANTIES OF MERCHANTABILITY & FITNESS FOR A PARTICULAR PURPOSE, DURABILITY OR DESCRIPTION OF THE PRODUCT, ITS NON-INFRINGEMENT OF ANY RELEVANT PATENTS OR TRADEMARKS, & ITS COMPLIANCE WITH OR NON-VIOLATION OF ANY APPLICABLE ENVIRONMENTAL, HEALTH OR SAFETY LEGISLATION; THE TERM OF ANY OTHER WARRANTY NOT HEREBY CONTRACTUALLY EXCLUDED IS LIMITED SUCH THAT IT SHALL NOT EXTEND BEYOND TWENTY-FOUR (24) MONTHS FROM THE PRODUCTION DATE, TO THE EXTENT THAT SUCH LIMITATION IS ALLOWED BY THE GOVERNING LAW.

**Product Warranty Return Procedure** All Products that are believed to have defects in workmanship or materials must be returned, together with a written description of the defect, to the tekmar Representative assigned to the territory in which such Product is located. If tekmar receives an inquiry from someone other than a tekmar Representative, including an inquiry from Purchaser (if not a tekmar Representative) or Purchaser's customers, regarding a potential warranty claim, tekmar's sole obligation shall be to provide the address & other contact information regarding the appropriate Representative.

**tekmar**<sup>®</sup>

A WATTS Brand

IOM-T-294EXP 2214

All specifications are subject to change without notice

Tel: 1-800-438-3903 • Fax: (250) 984-0815  
tekmarControls.com

© 2022 tekmar