

Multi-Staging

Replaces: 06/13

## Introduction

The Boiler Control 284 can communicate with a Building Automation System (BAS) using either BACnet® IP or Modbus®.

This manual provides information about boiler plant & system parameters that can be accessed by building automation or management systems that use BACnet® IP or Modbus® communication. The 284 can be configured to provide monitoring access or read / write access with optional target temperature control from the connected BAS.

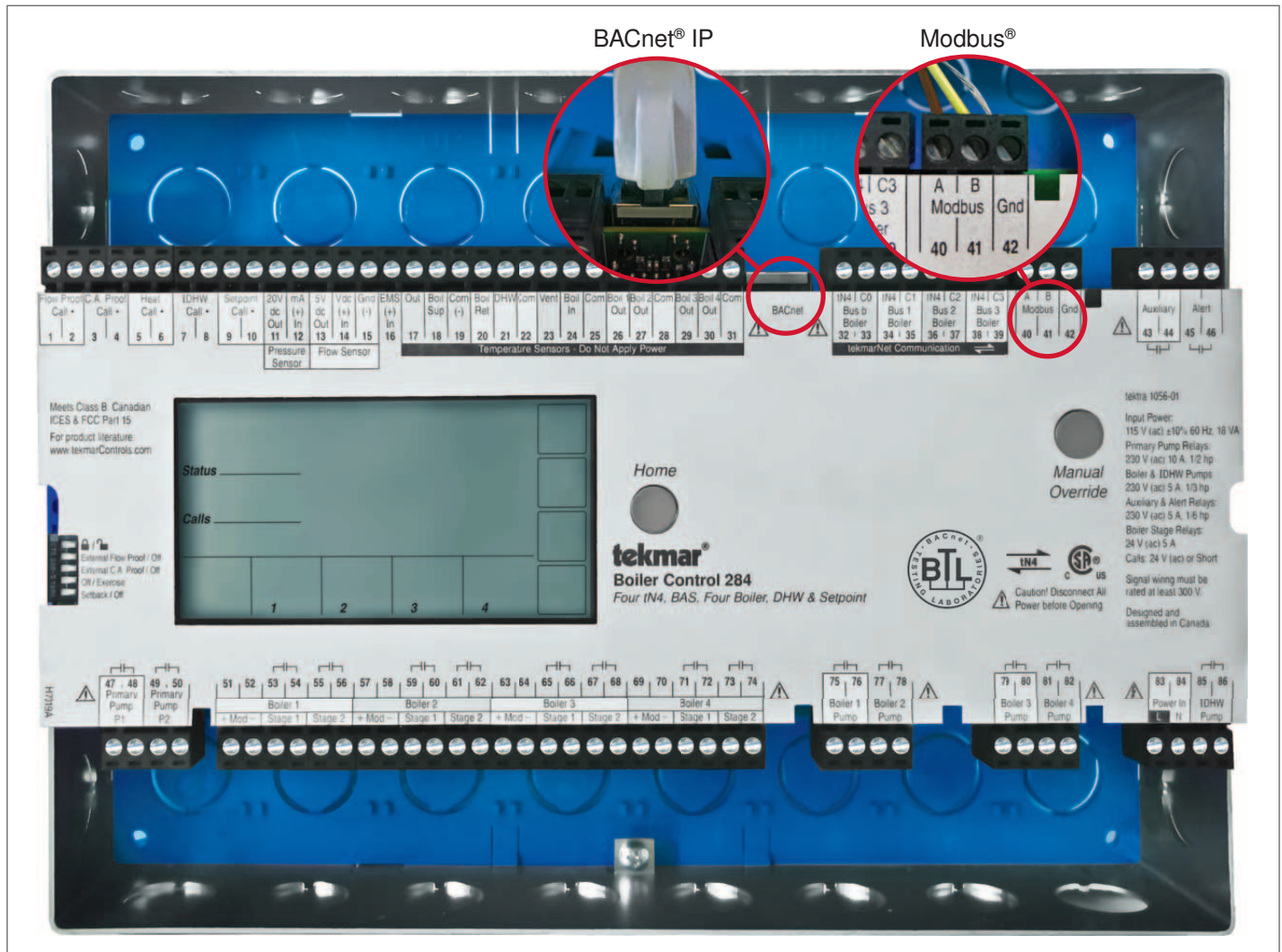

## Table of Contents



284 Configuration .....	2	BACnet® Analog Parameters .....	6
Lock / Unlock Switch .....	2	BACnet® Binary Parameters .....	7
Application Mode Setting .....	2	Modbus® Specification .....	8
BAS Type Setting .....	2	Modbus® Settings in the 284 BAS Menu .....	9
BACnet Protocol Implementation Conformance Statement (PICS) .....	3	Modbus® Parameters .....	10
BACnet® Connection .....	3	Modbus® Troubleshooting .....	11
BACnet® Settings in the 284 BAS Menu .....	4	Error Codes .....	12

## 284 Configuration

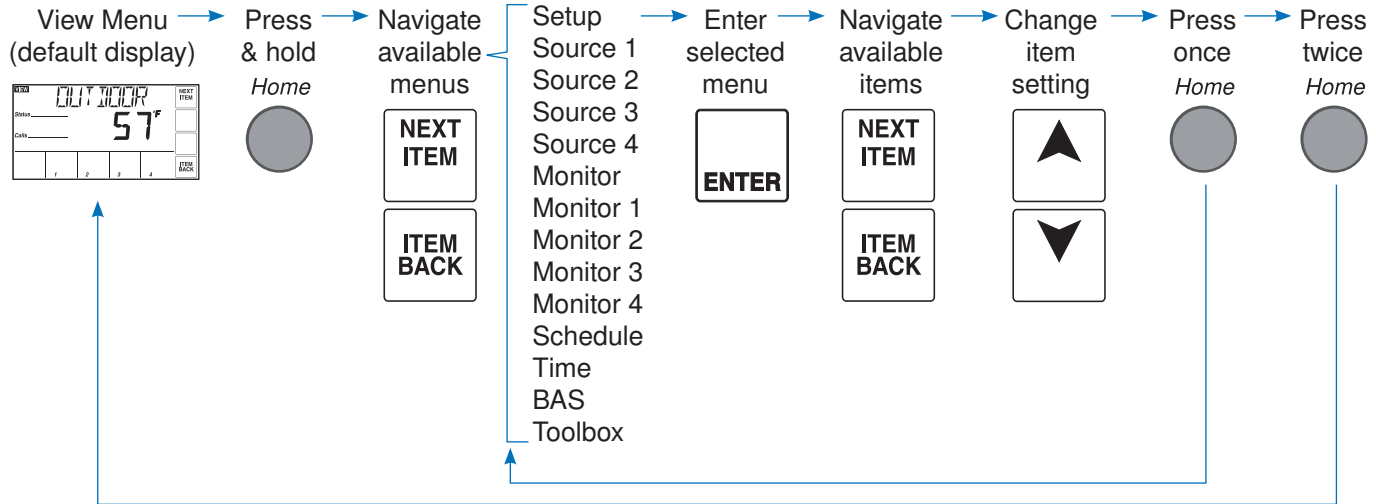
Ensure the 284 has the correct Application Mode & BAS Type settings before connecting to the BAS. To view menu selections in the 284, press & hold the Home button for 3 seconds.



### Lock / Unlock Switch

The 284 has an 'Advanced' access level that allows full access to all settings. To change from the Installer or User access to the Advanced access level, the  /  switch to the left side of the display on the front of the control must first be set to the unlock position. The access level can be changed in the toolbox menu.



### Application Mode Setting

The Application Mode of the 284 determines what options are available to the BAS.

284 Application Mode	BAS Operation
<b>RSET</b> Outdoor Temperature Reset	
<b>SETP</b> Setpoint	<u>BAS Monitor Mode</u> (BAS Monitor Setting set to ON) Remote monitoring & adjustment of select settings of the 284.
<b>DDHW</b> Dedicated Domestic Hot Water	Refer to the BACnet® & Modbus® Parameter Tables in this brochure for a listing of available read / write parameters.
<b>EMS</b> Energy Management System	
<b>BAS</b> Building Automation System	<u>BAS Temperature Mode</u> Provides Setpoint Temperature and Setpoint Call commands to the 284. Provides Primary Pump(s) and DHW Pump request commands to the 284. Remote monitoring & adjustment of select settings of the 284. Refer to the BACnet® & Modbus® Parameter Tables in this brochure for a listing of available read / write parameters.

### BAS Type Setting

Select the type of BAS connection in the BAS Menu of the 284.

284 BAS Type	BAS Operation
<b>BACnet® IP</b>	The 284 communicates with the BAS using the BACnet® Internet Protocol (IP) protocol.
<b>Modbus®</b>	The 284 communicates with the BAS using the Modbus® protocol.

## BACnet® Protocol Implementation Conformance Statement (PICS)

**Vendor Name:** tekmar Control Systems Ltd.

**Vendor ID:** 585

**Product Name:** Boiler Control 284

**Product Model Number:** 284

**Application Software Version:** J1120x

**Firmware Revision:** TBD

**BACnet Protocol Revision:** 10

### Product Description:

The 284 is a control that operates up to four boilers to provide heating for multiple loads. The control uses Proportional Integral Derivative (PID) logic to accurately maintain target temperature and offers advanced features including communication capability with a Building Automation System (BAS).

### BACnet Standardized Device Profile (Annex L)

BACnet® Application Specific Controller (B-ASC)

Supported BIBBs (Annex K)	Name
DS-RP-B	Data Sharing-ReadProperty-B
DS-RPM-B	Data Sharing-ReadPropertyMultiple-B
DS-WP-B	Data Sharing-WriteProperty-B
DM-DDB-B	Device Management-Dynamic Device Binding-B
DM-DOB-B	Device Management-Dynamic Object Binding-B
DM-DCC-B	Device Management-Device Communication Control-B

**Note:** DeviceCommunicationControl password is tekmar.

Segmentation Capability	Supported	Window Size
Able to transmit segmented messages	No	
Able to receive segmented messages	No	

Standard Object Types Supported	Creatable	Deletable
Analog Input	No	No
Analog Value	No	No
Binary Input	No	No
Binary Output	No	No
Binary Value	No	No

Data Link Layer	Supported
BACnet® IP (Annex J)	Yes

Device Address Binding	Supported
Static Device Address Binding	No

Network Security Options	Supported
Non-secure Device	

Character Set	Supported
ANSI X3.4	Yes

## BACnet® Connection

Use a top or back knock-out to bring a CAT-5E or CAT-6 wire into the wiring chamber. Connect the 284 to the BACnet® network switch using the RJ45 port on the top edge of the control board.

- Cable length must not exceed 150 ft. (45.7 m) for CAT-5E or 300 ft. (91.4 m) for CAT-6.
- If the cable was manually made, check continuity across each of the wires.

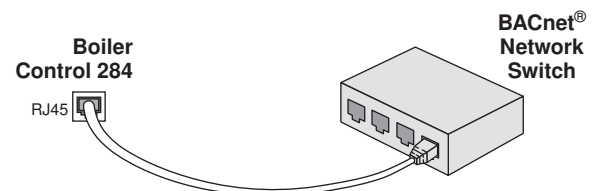

## BACnet® Settings in the 284 BAS Menu

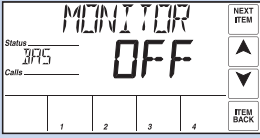
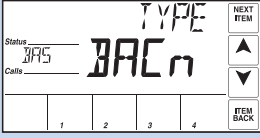
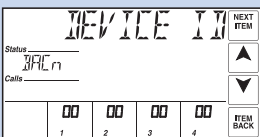
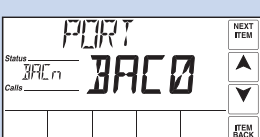
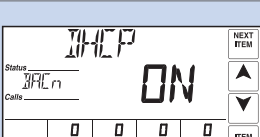
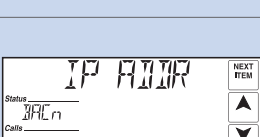
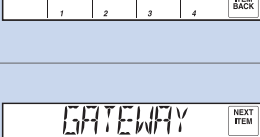
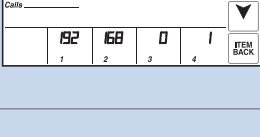
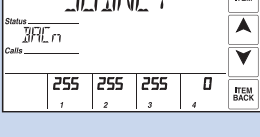
Item Field	Range	Description
	OFF or ON Default: OFF <hr/> Access: ADV	<b>BAS MONITOR</b> Selects whether or not BAS monitoring is available. <b>Note:</b> This item is only available when APP MODE is set to either RSET, SETP, DDHW or EMS.
	BACn, MODB Default: BACn <hr/> Access: ADV	<b>BAS TYPE</b> Selects the communication protocol used with the BAS network. Modbus® communicates over RS485 and BACnet® is over IP.
	0 to 4, 0 to 99, 0 to 99, 0 to 99 Default: 0, 0, 0, 0 <hr/> Access: ADV	<b>BACNET DEVICE ID</b> Sets the unique address within the BACnet® network. The address is set using four number sets displayed in the source output fields. Touch the 'Next Item' button to view and adjust each number set. <b>Note:</b> This item is only available when BAS TYPE is set to BACn.
	0x1 to 0xFFFF Default: 0xBAC0 (47808) <hr/> Access: ADV	<b>BACNET PORT</b> Sets the User Datagram Port (UDP) port on the BACnet® network. <b>Note:</b> This item is only available when BAS TYPE is set to BACn.
	OFF or ON Default: ON <hr/> Access: ADV	<b>BACNET DHCP</b> Selects whether or not the Dynamic Host Configuration Protocol (DHCP) is used to automatically assign the IP address on the BACnet® network. If ON is selected, the address is displayed in the source output fields. <b>Note:</b> This item is only available when BAS TYPE is set to BACn.
	0 to 255, 0 to 255, 0 to 255, 1 to 254 Default: 192,168,0,200 <hr/> Access: ADV	<b>BACNET IP ADDRESS</b> Sets the IP address on the BACnet® network. The address is set using four number sets displayed in the source output fields. Touch the 'Next Item' button to view and adjust each number set. <b>Note:</b> This item is only available when BAS TYPE is set to BACn and BACn DHCP is set to OFF.
	0 to 255, 0 to 255, 0 to 255, 1 to 254 Default: 192,168,0,1 <hr/> Access: ADV	<b>BACNET GATEWAY</b> Sets the Gateway address on the BACnet® network. The address is set using four number sets displayed in the source output fields. Touch the 'Next Item' button to view and adjust each number set. <b>Note:</b> This item is only available when BAS TYPE is set to BACn and BACn DHCP is set to OFF.
	0 to 255, 0 to 255, 0 to 255, 0 to 255 Default: 255,255,255,0 <hr/> Access: ADV	<b>BACNET SUBNET</b> Sets the subnet address on the BACnet® network. The address is set using four number sets displayed in the source output fields. Touch the 'Next Item' button to view and adjust each number set. <b>Note:</b> This item is only available when BAS TYPE is set to BACn and BACn DHCP is set to OFF.
	OFF, 30 to 65535 Default: OFF <hr/> Access: ADV	<b>BACNET BBMD TIME</b> Sets the Bacnet® Broadcast Management Device (BBMD) time-to-live used for foreign device registration. <b>Note:</b> This item is only available when BAS TYPE is set to BACn.

## BACnet® Settings in the 284 BAS Menu

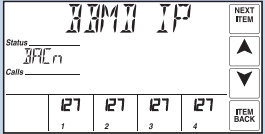
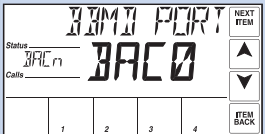
Item Field	Range	Description
	<p>0 to 255, 0 to 255, 0 to 255, 0 to 255</p> <p>Default: 127,127,127,127</p> <p>Access: Adv</p>	<p><b>BACNET BBMD IP</b></p> <p>Sets the BBMD IP address on the BACnet® network. The address is set using four number sets displayed in the source output fields. Touch the 'Next Item' button to view and adjust each number set.</p> <p><b>Note:</b> This item is only available when BAS TYPE is set to BACn and BBMD TIME is not set to OFF.</p>
	<p>0x1 to 0xFFFF</p> <p>Default: 0xBAC0 (47808)</p> <p>Access: Adv</p>	<p><b>BACNET BBMD PORT</b></p> <p>Sets the BBMD UDP port on the BACnet® network.</p> <p><b>Note:</b> This item is only available when BAS TYPE is set to BACn and BBMD TIME is not set to OFF.</p>

## BACnet® Analog Parameters

Analog Input Object = AI

Analog Value Object = AV

Read = R

Read / Write = R / W

(n) represents the specific Boiler number, including 1, 2, 3 and 4.

Object ID	Name	Description	Data Type	Read / Write	Units	Range / Value
<i>Analog Input Objects</i>						
0	Boil TARG	Boiler Target Temperature	AI	R	°F (64)	-22 to 266 °F
1	Boil MIN	Minimum Boiler Target Temperature	AI	R	°F (64)	60 to 180 °F
2	Boil MAX	Maximum Boiler Target Temperature	AI	R	°F (64)	90 to 225 °F
3	Boil SUP	Boiler Supply Temperature	AI	R	°F (64)	-22 to 266 °F
4	Boil RET	Boiler Return Temperature	AI	R	°F (64)	-22 to 266 °F
5	OUTDOOR	Outdoor Air Temperature	AI	R	°F (64)	-76 to 149 °F
6	DHW	DHW Tank Temperature	AI	R	°F (64)	-22 to 266 °F
7	VENT	Vent Temperature	AI	R	°F (64)	-22 to 266 °F
8	Boil INLET	Boiler Inlet Temperature	AI	R	°F (64)	-40 to 500 °F
9	FLOW RATE	Flow Rate	AI	R	GPM (89)	0 to 65535 gpm
10	ENERGY	Energy Usage	AI	R	Therms (21)	0 to 65535 Therms
11	PRESSURE	System Pressure	AI	R	PSI (56)	0 to 65535 psi
12	PRIM P1 RT	Primary Pump 1 Running Time	AI	R	Hours (71)	0 to 65535 Hours
13	PRIM P2 RT	Primary Pump 2 Running Time	AI	R	Hours (71)	0 to 65535 Hours
14	DHW P RT	DHW Pump Running Time	AI	R	Hours (71)	0 to 65535 Hours
15	ERROR	Current Error	AI	R	N/A (95)	See Error List
16, 22, 28, 34	Boil (n) TYPE	Boiler (n) Type	AI	R	N/A (95)	0 = MOD, 1 = 1STG, 2 = 2STG, 3 = EMS1, 4 = EMS2
17, 23, 29, 35	Boil (n) OUT	Boiler (n) Outlet Temperature	AI	R	°F (64)	-22 to 266 °F
18, 24, 30, 36	Boil (n) MOD	Boiler (n) Modulating Output	AI	R	% (98)	0 to 100%
19, 25, 31, 37	BURNER (n)	Boiler (n) Running Time	AI	R	Hours (71)	0 to 65535 Hours
20, 26, 32, 38	CYCLES (n)	Boiler (n) Cycles	AI	R	N/A (95)	0 to 65535
21, 27, 33, 39	PUMP (n) RT	Boiler (n) Pump Running Time	AI	R	Hours (71)	0 to 65535 Hours
<i>Analog Value Objects</i>						
0	SETPOINT	BAS Setpoint Temperature	AV	R/W	°F (64)	60 to 225 °F
1	ROOM Occ	Room Occupied Temperature	AV	R/W	°F (64)	35 to 100 °F
2	ROOM UnOcc	Room UnOccupied Temperature	AV	R/W	°F (64)	35 to 100 °F
3	OUT DSGN	Outdoor Design Temperature	AV	R/W	°F (64)	-60 to 45 °F
4	TERMINAL	Terminal Unit Type	AV	R/W	N/A (95)	0 = HRF1, 1 = HRF2, 2 = CONV, 3 = COIL, 4 = RAD, 5 = BASE
5	OUTDOOR	BAS Outdoor Air Temperature	AV	R/W	°F (64)	-85 to 149 °F (-85 °F = invalid temp. / no BAS sensor)

## BACnet® Binary Parameters

Binary Input Object = BI    Binary Output Object = BO    Binary Value Object = BV    Read = R    Write = W  
 (n) represents the specific Boiler number, including 1, 2, 3 and 4.

Object ID	Name	Description	Data Type	Read / Write	Units	Range / Value
<i>Binary Input Objects</i>						
0	PRIM P1	Primary Pump 1 Status	BI	R	N/A	0 = Off, 1 = On
1	PRIM P2	Primary Pump 2 Status	BI	R	N/A	0 = Off, 1 = On
2	DHW PUMP	DHW Pump Status	BI	R	N/A	0 = Off, 1 = On
3	SETBACK	Setback Status	BI	R	N/A	0 = Off, 1 = On
4	AUX RLY	Auxiliary Relay Status	BI	R	N/A	0 = Off, 1 = On
5	ALERT RLY	Alert Relay Status	BI	R	N/A	0 = Off, 1 = On
6	HEAT CALL	Heat Call Status	BI	R	N/A	0 = Off, 1 = On
7	DHW CALL	DHW Call Status	BI	R	N/A	0 = Off, 1 = On
8	SETP CALL	Setpoint Call Status	BI	R	N/A	0 = Off, 1 = On
9	FLOW PROOF	Flow Proof Call Status	BI	R	N/A	0 = Off, 1 = On
10	CA PROOF	C.A. Proof Call Status	BI	R	N/A	0 = Off, 1 = On
11, 13, 15, 17	CONDENSE (n)	Boiler (n) Condensing	BI	R	N/A	0 = No, 1 = Yes
12, 14, 16, 18	B(n) PUMP	Boiler (n) Pump Status	BI	R	N/A	0 = Off, 1 = On
<i>Binary Output Objects</i>						
0	DHW PUMP	BAS DHW Pump Request	BO	R/W	N/A	0 = Off, 1 = On
<i>Binary Value Objects</i>						
0	BAS SETP CALL	BAS Setpoint Call	BV	R/W	N/A	0 = Off, 1 = On
1	BAS PRIM PMP REQ	BAS Primary Pump Request	BV	R/W	N/A	0 = Off, 1 = On
2, 3, 4, 5	ENABLE B(n)	Enable / Disable Boiler (n)	BV	R/W	N/A	0 = Enable, 1 = Disable

Refer to the 284\_D Installation & Operational Manual for additional information.

### Troubleshooting

#### If there is no communication, check the following:

- Check the ethernet cable. Cable length must not exceed 150 ft. (45.7 m) for CAT-5E or 300 ft. (91.4 m) for CAT-6.
- If the cable was manually made, check continuity across each of the wires.

#### If there is intermittent communication, check the following:

- Check the ethernet cable. Cable length must not exceed 150 ft. (45.7 m) for CAT-5E or 300 ft. (91.4 m) for CAT-6.

## Modbus® Specification

Communication Protocol	Modbus® over RS485
Physical Layer	RS485 two-wire plus signal ground
Baud Rate	2400, 9600, 19200, 57600, 115000 (default: 19200 bps)
Recommended Cable	18 AWG shielded, twisted pair (STP)
Transmission Mode	RTU or ASCII (default: RTU)
Maximum Cable Length	11500 bps: 580 ft (177 m) 57600 bps: 1,158 ft (353 m) 19200, 9600, 2400 bps: 3,280 ft (1,000 m) 3,280 ft (1,000 m) for all baud rates if 120 Ohm terminating resistors used
Start Bit	1 bit
Data Length	8 bits for RTU mode 7 bits for ASCII mode
Parity	None (2 stop bits) Even (1 stop bit) Odd (1 stop bit) (default: Even)
Addressing	1 to 247 (default: 1)

## Modbus® Connection

Use a top or back knock-out to bring a shielded twisted pair wire from the nearest Modbus® RS485 connection point into the wiring chamber. Wire the A, B & G conductors from the Modbus® point to the 284 A, B & Gnd terminals.

- Gnd should not be connected to the ground screws in the 284.

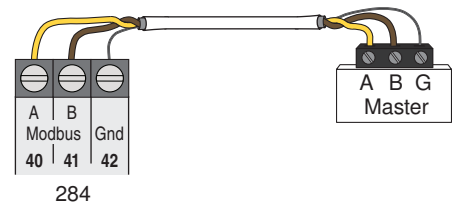

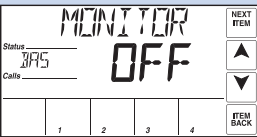
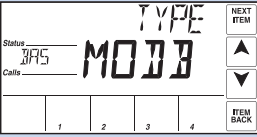
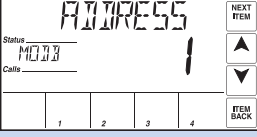
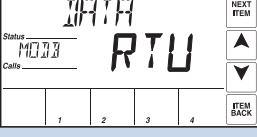
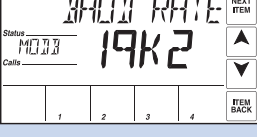
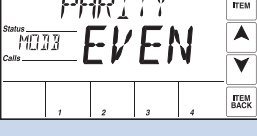

## Modbus® Settings in the 284 BAS Menu

Item Field	Range	Description
	<p>OFF or ON Default: OFF</p> <hr/> <p>Access: ADV</p>	<p><b>BAS MONITOR</b> Selects whether or not BAS monitoring is available. <b>Note:</b> This item is only available when APP MODE is set to either RSET, SETP, DDHW or EMS.</p>
	<p>NONE, BACn, MODB Default: BACn</p> <hr/> <p>Access: ADV</p>	<p><b>BAS TYPE</b> Selects the communication protocol used with the BAS network. Modbus® communicates over RS485 and BACnet® is over IP.</p>
	<p>1 to 247 Default: 1</p> <hr/> <p>Access: ADV</p>	<p><b>MODBUS ADDRESS</b> Sets the unique address within the Modbus® network. <b>Note:</b> This item is only available when BAS TYPE is set to MODB.</p>
	<p>RTU or ASCII Default: RTU</p> <hr/> <p>Access: ADV</p>	<p><b>MODBUS DATA</b> Selects whether the Modbus® data communication type is RTU or ASCII (ASCII). <b>Note:</b> This item is only available when BAS TYPE is set to MODB.</p>
	<p>2400, 9600, 19K2, 57K6, 115K Default: 19K2</p> <hr/> <p>Access: ADV</p>	<p><b>MODBUS BAUD RATE</b> Selects the communication speed. In order to ensure reliable communications, the baud rate on the control must be same as the Modbus® network. <b>Note:</b> This item is only available when BAS TYPE is set to MODB.</p>
	<p>NONE, EVEN, ODD Default: EVEN</p> <hr/> <p>Access: ADV</p>	<p><b>MODBUS PARITY</b> Selects the parity used for the Modbus® communication. <b>Note:</b> This item is only available when BAS TYPE is set to MODB.</p>

## Modbus® Parameters

Read = R

Read / Write = R / W

(n) represents the specific Boiler number, including 1, 2, 3 and 4.

Register	Parameter Name	Read /Write	Units	Type	Format	Range
<i>System Status Registers</i>						
1	Boiler Target Temperature	R	°F	Input	S16	-22 to 266°F
2	Boiler Minimum	R	°F	Input	S16	60 to 180°F
3	Boiler Maximum	R	°F	Input	S16	90 to 225°F
4	Boiler Supply Temperature	R	°F	Input	S16	-22 to 266°F
5	Boiler Return Temperature	R	°F	Input	S16	-22 to 266°F
6	Outdoor Air Temperature	R	°F	Input	S16	-76 to 149°F
7	DHW Temperature	R	°F	Input	S16	-22 to 266°F
8	Vent Temperature	R	°F	Input	S16	-40 to 500°F
9	Boiler Inlet Temperature	R	°F	Input	S16	-22 to 266°F
10	Flow	R	10*GPM	Input	U16	0 to 65535 gpm
11	Energy	R	Therms	Input	U16	0 to 65535 Therms
12	System Pressure	R	10*PSI	Input	U16	0 to 65535 psi
13	Primary Pump 1 Relay Status	R	Enum	Input	U16	0=Off, 1=On
14	Primary Pump 2 Relay Status	R	Enum	Input	U16	0=Off, 1=On
15	DHW Pump Relay Status	R	Enum	Input	U16	0=Off, 1=On
16	Primary Pump 1 Runtime	R	Hours	Input	U16	0 to 65535 Hours
17	Primary Pump 2 Runtime	R	Hours	Input	U16	0 to 65535 Hours
18	DHW Pump Runtime	R	Hours	Input	U16	0 to 65535 Hours
19	Setback Status	R	Enum	Input	U16	0 = Occ, 1 = UnOcc
20	Auxiliary Relay Status	R	Enum	Input	U16	0 = Off, 1 = On
21	Alert Relay Status	R	Enum	Input	U16	0 = Off, 1 = On
22	Heat Call Status	R	Enum	Input	U16	0 = Off, 1 = On
23	DHW Call Status	R	Enum	Input	U16	0 = Off, 1 = On
24	Setpoint Call Status	R	Enum	Input	U16	0 = Off, 1 = On
25	Flow Proof Call Status	R	Enum	Input	U16	0 = Off, 1 = On
26	C.A. Proof Call Status	R	Enum	Input	U16	0 = Off, 1 = On
27	Error Code	R	Enum	Input	U16	See Error Code List
<i>System Parameter Registers</i>						
1	Setpoint Call Request	R/W	Enum	Holding	U16	0 = Off, 1 = On
2	Setpoint Target Request	R/W	°F	Holding	U16	60 to 225°F
3	Primary Pump Request	R/W	Enum	Holding	U16	0 = Off, 1 = On
4	IDHW Pump Request	R/W	Enum	Holding	U16	0 = Off, 1 = On
5	Room Occupied	R/W	°F	Holding	S16	35 to 100°F
6	Room UnOccupied	R/W	°F	Holding	S16	35 to 100°F
7	Outdoor Design Temperature	R/W	°F	Holding	S16	-60 to 45°F
8	Terminal Unit Type	R/W	Enum	Holding	U16	0 = HRF1, 1 = HRF2, 2 = CONV, 3 = COIL, 4 = RAD, 5 = BASE
9	Outdoor Temperature	R/W	°F	Holding	S16	-85 to 149°F (-85°F = invalid temp. / no BAS sensor)

## Modbus® Parameters

Read = R

Read / Write = R / W

(n) represents the specific Boiler number, including 1, 2, 3 and 4.

Register	Parameter Name	Read /Write	Units	Type	Format	Range
<i>Boiler Status Registers</i>						
10,11,12,13	Boiler (n) Enable/Disable	R/W	Enum	Holding	U16	0 = Enable, 1 = Disable
28,36,44,52	Boiler (n) Type	R	Enum	Input	U16	0 = MOD, 1 = 1STG, 2 = 2STG, 3 = EMS1, 4 = EMS2
29,37,45,53	Boiler (n) Condensing	R	Enum	Input	U16	0 = No, 1 = Yes
30,38,46,54	Boiler (n) Outlet Temperature	R	°F	Input	S16	-22 to 266°F
31,39,47,55	Boiler (n) Modulation Rate	R	%	Input	U16	0 to 100%
32,40,48,56	Boiler (n) Runtime	R	Hours	Input	U16	0 to 65535 Hours
33,41,49,57	Boiler (n) Cycles	R	Num	Input	U16	0 to 65535
34,42,50,58	Boiler (n) Pump Status	R	Enum	Input	U16	0 = Off, 1 = On
35,43,51,59	Boiler (n) Pump Runtime	R	Hours	Input	U16	0 to 65535
<i>Product Information</i>						
60	Product Model	R	Num	Input	U16	284
61	Firmware Revision	R	Num	Input	U16	SVN revision
62	Application Version	R	Num	Input	U16	J number letter (A=1, B=2,...)

## Modbus® Troubleshooting

### If there is no communication, check the following:

- Check that the polarity on the Modbus® A & B terminals is correct.
- Check that Modbus® GND terminal is securely connected.
- Check that the Baud Rate on both devices are the same.

### If the communication is intermittent, check the following:

- Check that the communication cable is of the twisted pair type.
- Reliable communication depends on the cable length & Baud rate used. Long cable length may require a lower Baud Rate.

## Error Codes

Code	Description
0	No Error
1	EEPROM Error
2	Boiler Supply Sensor Error
3	Boiler Return Sensor Error
4	DHW Sensor Error
5	Outdoor Sensor Error
6	Vent Sensor Error
7	Boiler 1 Outlet Sensor Error
8	Boiler 2 Outlet Sensor Error
9	Boiler 3 Outlet Sensor Error
10	Boiler 4 Outlet Sensor Error
11	Boiler 1 Maximum Outlet Temperature Warning
12	Boiler 2 Maximum Outlet Temperature Warning
13	Boiler 3 Maximum Outlet Temperature Warning
14	Boiler 4 Maximum Outlet Temperature Warning
15	Boiler Inlet Sensor

Code	Description
16	Flow Proof Error
17	C.A. Proof Error
18	Vent Maximum Temperature Warning
19	No Heat Warning
20	tN4 Duplicate Master
21	tN4 Schedule Master
22	tN4 Schedule Member
23	tN4 Device Lost (Bus b)
24	tN4 Device Lost (Bus 1)
25	tN4 Device Lost (Bus 2)
26	tN4 Device Lost (Bus 3)
27	tN4 Device Error (Bus b)
28	tN4 Device Error (Bus 1)
29	tN4 Device Error (Bus 2)
30	tN4 Device Error (Bus 3)